

ZIPF LOCK COMPANY

ALARM LOCK

T2 SERIES DIGITAL LOCKS

- ANSI/BHMA A156.2, Series 4000, UL Listed Grade 1



- **STRENGTH**
- **RELIABILITY**
- **INTEGRITY**

Alarm Lock 2700 Series Trilogy

NOTE: The DL2700 Series can not be used on exterior applications unless you order the **WP**.



AK-DL2750
US-26D

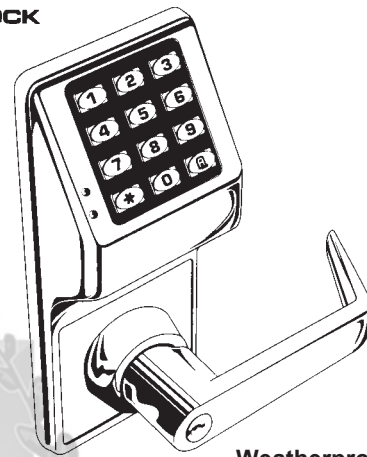

AK-DL2700
US-3, 5, 26D

Weatherproof
AK-DL2700WP
26D

Features:

Keypad: Vandal-Resistant 12-button metal
Operation: Rugged clutch
Handing: Non-handed
User Codes: 17
Code Length/No. of Codes: 3-5 digit codes; 29,000,000 codes
User Levels: Master, Manager, User, 1X Service
Special Functions: Passage, Individual, Group, Total Lockout
Programming: Keypad
Audit Trail Events: n/a
Scheduled Events: n/a
Remote Release Option: Yes, by special order.
Relay Control: Yes, for example an external siren or CCTV can be triggered

Power: 5 AA batteries, Supplied
Typical Cycles/Battery Indication: 100,000; visual & audible low-batt. indicator
Weather-Resistant Models: Order AK-DL2700WP model
Operating Range of Above WP's: WP's: -20° to +151°F
Proximity Card Support: n/a
Finishes: US3, 5, 26D
Trim: Standard squared lever
Door Thickness: 1-5/8" to 1-7/8"
Backset: 2-3/4"
Latchbolt: UL, 3 Hour, Fired-rated 1/2" throw solid brass
Strikes: 1-1/8" x 2-3/4" T strike & 1-1/4" x 4-7/8" ASA
Cylinder: 6-pin solid brass, SC1 keyway

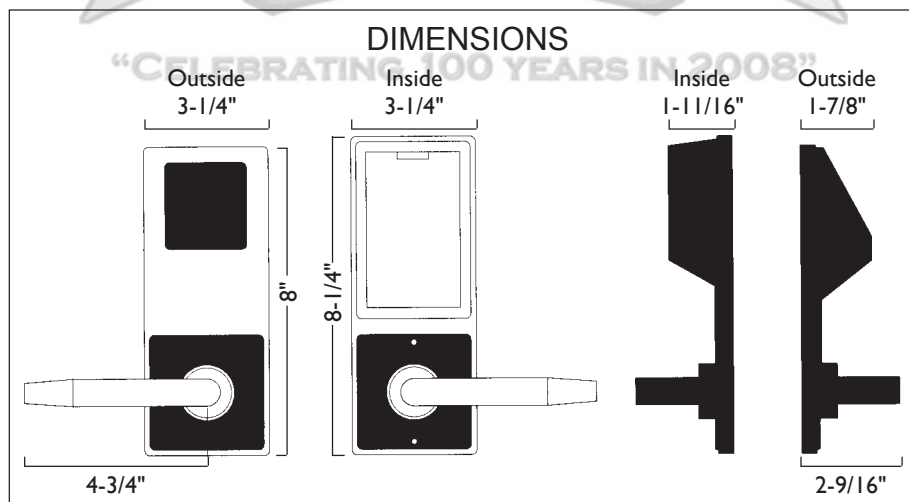

Continued on next page

©ZIPF LOCK COMPANY

103^{v1}
(PL-1)

"Your warehouse around the corner"

ZIPF LOCK COMPANY

ALARM LOCK

T2 SERIES DIGITAL LOCKS

- Continued from previous page.



ALARM LOCK



FEATURES:

- Clutch mechanism offers exceptional reliability and strength.
- Super heavy-duty trim design with self-contained, fully programmable 12 digit metal keypad.
- Battery powered, uses five AA batteries for long-life dependability & audible low power alert.
- Non-handed for easy installation and versatility, retrofit or new.
- 2-wire remote override or key bypass capability.
- Visual and audible entry indicators.
- Available in lever or knob design with rekeyable cylinder (interchangeable core version-special factory order).
- UL Listed Grade One lockset with fire rated latch meets or exceeds BHMA specifications.
- Choose from polished brass, antique brass or satin chrome. (Polished chrome-special factory order)

12 KEY PROGRAMMABLE ACCESS CODES

- Multi-level user capability.
- Master code.
- Manager code.
- Passage function.
- One time emergency or service entrance code-erases from memory after use.
- Timed entry allowance from 5 to 20 seconds.
- Up to 15 different group or individual codes.
- Individual, group or total user lockout code.
- Master and management can temporarily or permanently change any or all user codes.
- Temporarily shuts down if incorrect code is entered three times consecutively..

INSTALLATION KITS

By ProLok

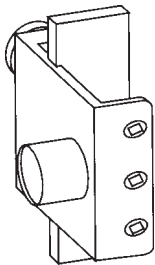

PK-INCL

Universal Clamp

The cornerstone of our Professional Installation Series. Holds all of the specialty templates without damage to the door's finish. Complete with an easy to use 1-1/2" sure-grip knob for quick and positive hand tightening. For 1-3/4" door with a 2-3/4" backset.

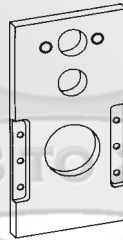

PK-IN10

Simplex/Trilogy

Preps door for Simplex 1000 Series locks and Trilogy push button locks.

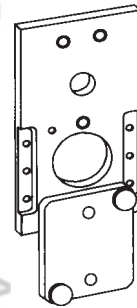

PK-IN15

Alarm Lock Trilogy T-2 Preps door for OLD Style Trilogy T-2 Series locks.

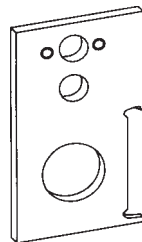

PK-IN10R

Reverse Simplex/Trilogy

Same as IN10 but preps reverse side of door.

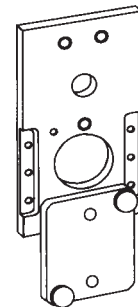

PK-IN15A

Alarm Lock Trilogy T-2, T-3

Preps door for NEW STYLE Trilogy T-2, T-3 all cylindrical locks.

"CELEBRATING 100 YEARS IN 2008"

©ZIPF LOCK COMPANY

104

(PL-1)

"Your warehouse around the corner"

ZIPF LOCK COMPANY

EXIT DEVICES

PILFERGARD PG-10

- Mini-Burglar Alarm.
- Low-Cost.
- Twin Action Horns.
- Easily Installed.



ALARM LOCK

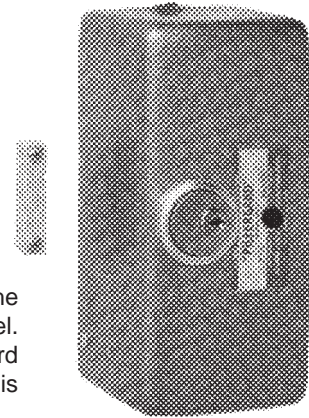

AK-PG-10

Stock No. **Finish**
AK-PG-10 Metallic Silver

The Pilfergard model AK-PG-10 is an exit door alarm designed to deter the use of the secured door by sounding a twin action alarm when opened by unauthorized personnel. The alarm can be bypassed from inside or outside by use of a key. (Requires standard mortise cylinder not supplied.) This durable surface mount unit is easily installed and is tamper-supervised with two separate tamper switches. Its test button verifies battery.

SIRENLOCK™

- Narrow stile door alarms.
- Convenient plug-in No-Cut jumpers.
- Improved 95db sweeping siren.
- Visual magnetic alignment mode, eliminates templates.
- Self-contained and dual-tamper supervised.
- 9v-battery powered (supplied) with low battery alert.

Stock No **Finish**
AK-PG-21 MB Duronodic
AK-PG-21 MS Metallic Silver

Sleek model design key-activated door alarm for use on standard size and narrow stile doors. Unauthorized use of door will cause alarm to sound and will activate the LED indicator. User selectable options include: continuous alarm, minute shutdown with auto reset and exit/entry delay. Only key carrying employees can disable the alarm; uses standard mortise cylinder (not included). (For exterior key control, an optional RIM cylinder may also be used.) Finishes: metallic silver or Duronodic.

Cylinder pictured
NOT included

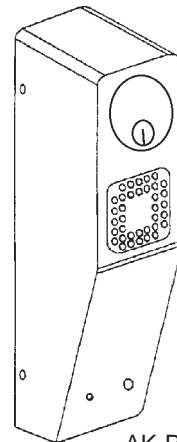

AK-PG-21

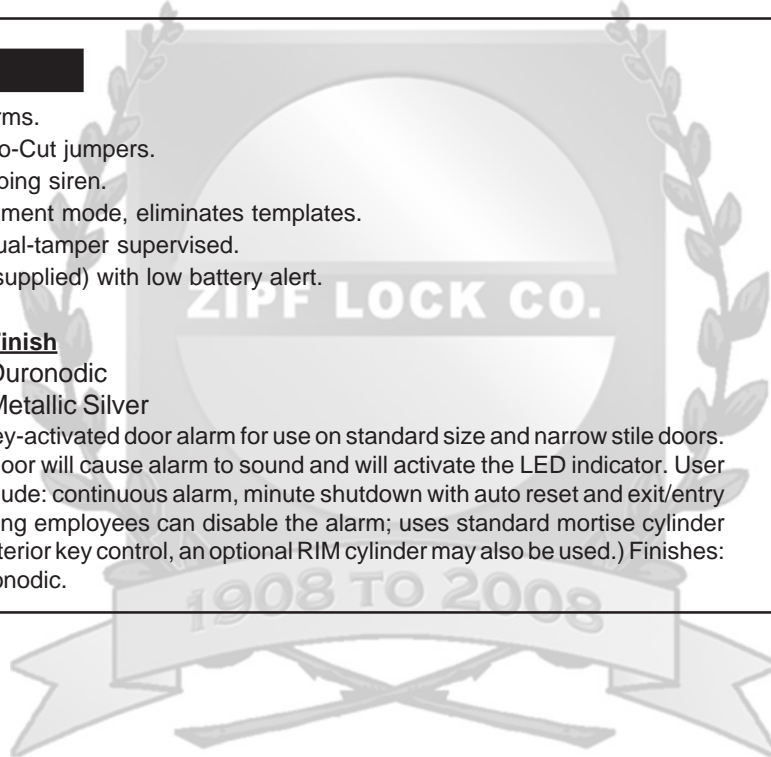

“CELEBRATING 100 YEARS IN 2008”

ZIPF LOCK COMPANY

EXIT DEVICES

SIRENLOCK™

- Deadbolt & Deadlatch meet relatching requirements.
- Free retrofit cover plates conceal mounting holes from models 11A and 230.
- Blaring 95db dual tone piezo siren.
- Selectable 2-minute alarm or constant alarm.
- 9V battery Powered & audible low battery warning.
- Meets or exceeds UL, CFM, ADA, NYC Housing.

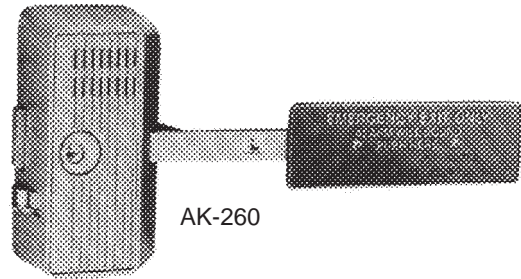

AK-260

Stock No.

AK-260 MS Changeable 2-minute auto reset or manual reset. Model 260 is a UL Listed panic alarm deadbolt device which restrict unauthorized use of exit doors by sounding an alarm, while providing instant egress in emergencies. High security deadlatch and deadbolt for extra protection.

Stock No.

AK-700 MS Changeable 2-minute alarm cutoff or manual reset.

AK-710 MS Changeable 2-minute auto reset or manual reset. Models 700 & 710 are UL Listed panic alarm deadbolt devices which restrict unauthorized use of exit doors by sounding an alarm, while providing instant egress in emergencies. High security deadlatch and deadbolt for extra protection.



AK-700
AK-710

SIRENLOCK™ w/DELAY

| Stock No. | Finish |
|---------------------|-----------------|
| AK-715 US28 | Metallic Silver |
| AK-715 US312 | Duranodic |

Features:

- 15-Second delayed egress with instant 95db dual piezo horn alarm (Meets UL specifications).
- Instant alarmed exit in case of actual emergency or fire (Meets NFPA 1012 Life Safety Code).
- Monitoring output for simultaneous use of CCTV camera, secondary siren, remote monitoring console, etc.
- Smoke detector input can be used to power existing system's or stand-alone smoke detector(s). (includes armored door cord and cables for wiring)
- 9-Volt battery back-up powers siren in event of power failure.

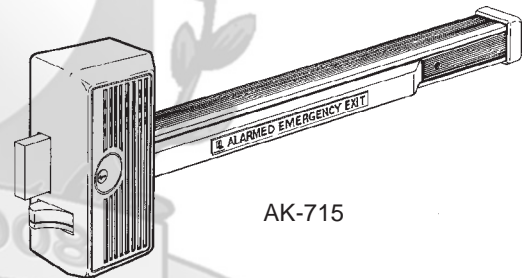

AK-715

Easy-to-install, surface mount unit in a standard panic bar deadbolt/deadlatch design

ZIPF LOCK COMPANY

EXIT DEVICES

ACCESSORIES



ALARM LOCK

Battery Pack (6-Volt) *Not Shown.*

AK-BP6

For use with: Models AK-PG-10, 11A and PG20.

Outside Access Door Pull

AK-707 MS Metallic Silver Finish

For access from building exteriors. Installed on the outside of the door and linked to the lock. After deadbolt is retracted by outside key, a slight pull will release the deadlatch and open the door. 8" x 1-1/2". (For use with all models except AK-11A).



AK-707

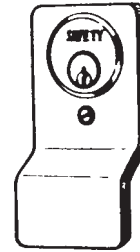

AK-711

Cylinder Finger Pull

AK-711 MS Metallic Silver Finish

For use with: Models AK-11A, 250, 260, 700 and 710. An inexpensive door pull for use when outside key only access is required.



AK-732

Double Door Strike

AK-732

FINISHES: US28-Aluminum

For use with models 250, 700 and 80.