

CHEST, CUPBOARD & DRAWER LOCKS

SPECIAL PURPOSE DRAWER & DOOR LOCK

CompX
CHICAGO

- Six disc tumbler plug in 3/4" diameter.
- Die Cast barrel with two flats—21/32" across.
- Key and cam rotation 90° from locked (12 O'clock) to unlocked (3 O'clock) position with keypull in both positions.
- This lock designed to be used with customer's latching mechanism.
- Standard finish: Satin Nickel.
- Two keys furnished per lock.

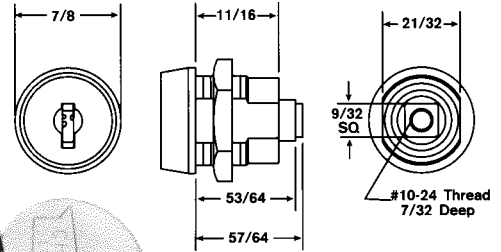
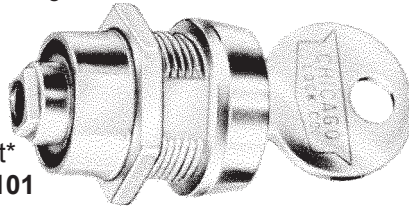

Stock No.

C17256TNH KV*

C17256TNH KA

Keying

Keyed Different*

Keyed Alike: 1101

*KV indicates the majority of the quantity of locks will be keyed different. A lesser quantity will potentially be keyed alike to one or more key numbers. We can not guarantee that we can ship keyed DIFFERENT locks.

BOLT TYPE LOCKS

- Five Disc tumbler.
- Removable plug feature.
- Steel locking bolt.
- Furnished with two keys per lock.

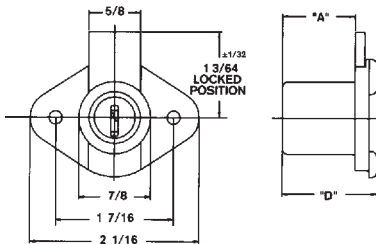

C1968

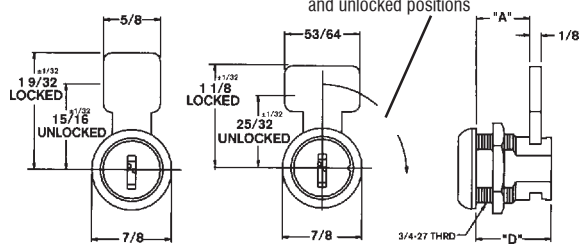

C1975

C1974

Turn key 180° to unlock.
Key removable in locked
and unlocked positions

<u>Stock No.</u>	<u>A</u>	<u>D</u>	<u>Finish</u>	<u>Keyed Alike Numbers Available</u>
C1968	57/64"	1-5/32"	Brushed Brass	1289, 1454
C1974	19/32"	27/32"	Satin Chrome	1289, 1454
C1975	21/32"	57/64"	Satin Chrome	1289, 1454

Available KV-Keyed Different or KA-Keyed Alike. **Specify KV or KA**

*KV indicates the majority of the quantity of locks will be keyed different. A lesser quantity will potentially be keyed alike to one or more key numbers. We can not guarantee that we can ship keyed DIFFERENT locks.

**Need a Chicago item not shown??
Call us today !!**

CHEST, CUPBOARD & DRAWER LOCKS

KD-Keyed Different
KA-Keyed Alike, Specify #



Discontinued. Call for closeout prices.

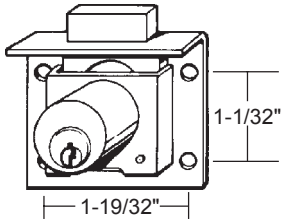

Pin Tumbler
0666 7/8 KA
 KA# 4T37526

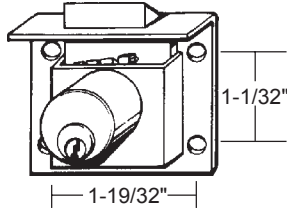

Pin Tumbler
0666 1/2-7/8 KA
 KA# 4T50316

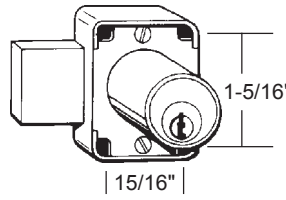

Pin Tumbler
0737 7/8 KA
 KA# B4R37539

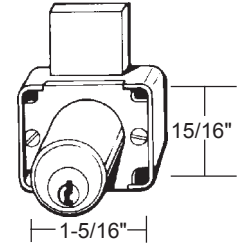

Pin Tumbler
0738 7/8 KD
0738 7/8 KA
 KA# 4T27543

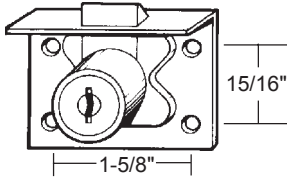

Disc Tumbler
02065 1/2-7/8" KD
02065 1/2-7/8" KA
 KA# CAT65

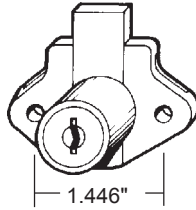

Disc Tumbler
02066 3/4" KD
02066 3/4" KA
 KA# AUE1, CAT30

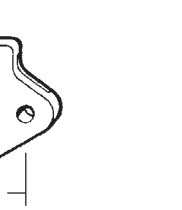

Disc Tumbler
02066 7/8" KD
02066 7/8" KA
 KA# CAT9

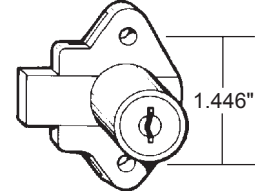

Disc Tumbler
02067 3/4" KD

Disc Tumbler
02067 7/8" KD

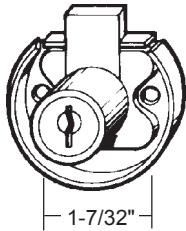

Disc Tumbler
02068 7/8" Deadbolt
02068 1/2-7/8" Latchbolt
 KD only

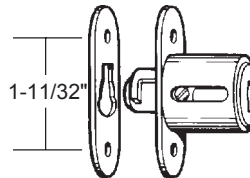

Disc Tumbler
02069 7/8" KD
02069 7/8" KA
 KA# CAT30

Stock No.	Size	Material	Backset	For Wood	Finish	Keyway
0666 7/8"	2"x1-5/8"	Brass	7/8"	7/8"	US-4	8618C-R1
0666 1/2-7/8"	2"x1-5/8"	Brass	7/8"	7/8"	US-4	8618C-R1
0737 7/8"	1-1/4"x1-5/8"	Brass ^A	5/8"	7/8"	US-4	8618C-R1
0738 7/8"	1-5/8"x1-1/4"	Brass ^A	5/8"	7/8"	US-4	8618C-R1
02065 1/2-7/8"	2-1/64"x1-9/16"	Die Cast ^B	3/4"	7/8"	US-4	5865JVR
02066 3/4"	2-1/16"x1-7/16"	Die Cast ^B	3/4"	3/4"	US-4	5865JVR
02066 7/8"	2-1/16"x1-7/16"	Die Cast ^B	3/4"	7/8"	US-4, 26D	5865JVR
02067 3/4"	1-7/16"x2-1/16"	Die Cast ^B	3/4"	3/4"	US-4	5865JVR
02067 7/8"	1-7/16"x2-1/16"	Die Cast ^B	3/4"	7/8"	US-4	5865JVR
02068 7/8"	1-3/4"x1-5/8"	Die Cast ^B	3/4"	7/8"	US-4	5865JVR
02068 1/2-7/8"	1-3/4"x1-5/8"	Die Cast ^B	3/4"	7/8"	US-4	5865JVR
02069 7/8"	2"x7/8"	Brass/Cast ^C	7/8"	7/8"	US-4	5865JVR

^APressure cast case, brass cylinder

^BBrass plated steel backplate & bolt, Pressure cast cylinder

^CBrass outside cylinder, pressure cast plug

Note: CCL is being phased out. If out, please check other manufacturers in this section.

©ZIPP LOCK COMPANY

260_{v1}
 (PL-20)

Also be sure to check "DESKS LOCK" if you cannot find it here.

CHEST, CUPBOARD & DRAWER LOCKS

23000 SERIES SINGLE BITTED DRAWER LOCKS W/UNIVERSAL KEYWAY

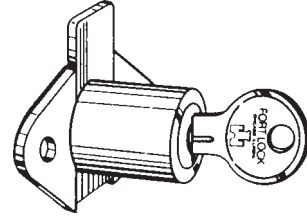

- Single bitted.
- Universal Keyway—K54G. (See next page)
- Multi-function—Latch & Deadlatch included.
- Keypull at 12:00 & 3:00.
- Finish: Brass or Stainless Steel.
- Two keys furnished per lock.

Stock No.	Finish	Hole Diameter	Keyed Alike Numbers Available
MFW-23007	Stainless Steel	7/8"	221
MFW-23007B	Brass	7/8"	217
MFW-23008B	Brass	1-1/8"	217

Available **KD**-Keyed Different or **KA**-Keyed Alike. *Specify KD or KA*

23000 SERIES MULTI-FUNCTION METAL DRAWER LOCK w/UNIVERSAL KEYWAY

- Single bitted.
- Multi-function—2 bolt throw heights.
- Bolt notched for assembled installation.
- 90° key turn to open.
- Key removable locked or unlocked.
- Removable cylinder for rekeying.
- Finish: Brass or Stainless Steel.
- Two keys furnished per lock.

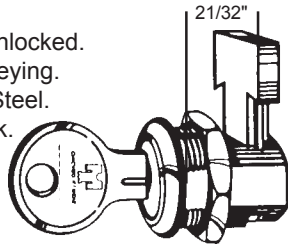

Stock No	Keying
MFW-23010 KD	Keyed Different
MFW-23010 KA	Keyed Alike—217, 221, 224, 237, 238

1000 SERIES HIGH SECURITY TUBULAR DRAWER LOCK

- 7 pin tumbler.
- 3/8" bolt throw.
- Keypulls at 12:00 & 6:00.
- 180° key turn to open
- Standard finish: Chrome Plated.
- Two keys furnished per lock.

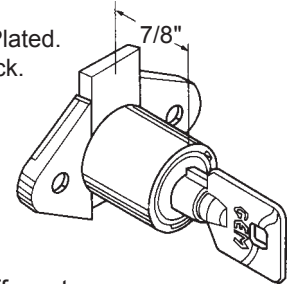

Discontinued. Call for closeout prices.

Stock No	Keying
DR-1008 KD	Keyed Different
DR-1008 KA	Keyed Alike—27379, 27380

DRAWER AND CABINET LOCKS

- Single bitted.
- Key removable at 12:00 & 6:00.
- Keyway: O1014S.
- 7/8" diameter.
- Brass finish.

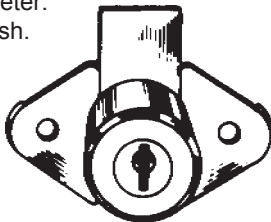

Stock No.	Barrel Length	Keyed Alike Number Available
1701-04-11	3/4"	EB78
1702-04-11	7/8"	EB8, EB72, EB78, EB92

Available **KD**-Keyed Different or **KA**-Keyed Alike. *Specify KV or KA*

BRASS WOOD DRAWER LOCKS

- Single bitted.
- Keyway: IN8.
- Brass finish.
- Two keys per lock.
- 7/8" diameter.



CONVERSION CHART

Jet	DR0782	DR1182
Fort	MFW23007	MFW23008
CCL	02066-7/8	02066-1 1/8
Chicago	C1968	
ESP	875WD	1125WD
National	C8803	

Stock No.	Barrel Length	Keyed Alike Number Available
JT-DR0782	7/8"	330,331
JT-DR1182	1-1/8"	330,331

Available **KD**-Keyed Different or **KA**-Keyed Alike. *Specify KD or KA*

©ZIPF LOCK COMPANY

Also be sure to check "DESKS LOCK" if you cannot find it here.

CHEST, CUPBOARD & DRAWER LOCKS

PIN TUMBLER DOOR AND DRAWER LOCKS

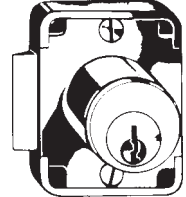
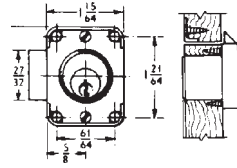
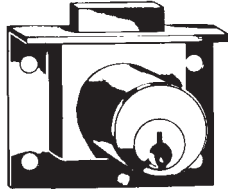
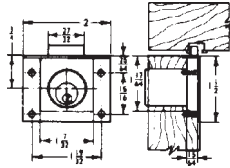
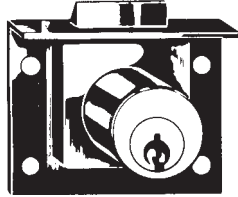

NL-C8131

NL-C8133
NL-C8135

NL-C8139

APPLICATION—For drawers. Half mortise type requires mortise for housing and 57/64" dia. hole for cylinder. NL-C8139 is surface mounted.

OPERATION—Key removable in both locked and unlocked positions except NL-C8131 and NL-C8139.

KEYING—Will key together with all other pin tumbler locks using D4291 key blank except NL-C8700 mail box locks. Available keyed different (**KD**) or keyed alike (**KA**).

KEY BLANK—D4291.

PACKAGING—Supplied with two keys, strike and mounting screws.

FINISHES—4-Satin Brass, 26D- Dull Chrome.

Stock #	Installation	Bolt Type	Cylinder Length	Bolt Travel	Keyed Alike Numbers Available
NL-C8131-4*	Drawer	Spring	7/8"	7/32"	107
NL-C8131-26D*	Drawer	Spring	7/8"	7/32"	101, 107, 915
NL-C8133-4	Drawer	Dead	7/8"	1/4"	107
NL-C8133-26D	Drawer	Dead	7/8"	1/4"	101, 107, 915
NL-C8135-26D	Drawer	Dead	1-1/8"	1/4"	101, 107
NL-C8139-26D*	Door	Spring	3/4"	7/32"	107, 915

*Key removable in locked position only.

Available **KD**-Keyed Different or **KA**-Keyed Alike. *Specify KD or KA*

PIN TUMBLER DOOR DRAWER LOCKS

APPLICATION—For center drawers of desks. Fits special piercing of drawer front and seldedge (see drawing). Reinforced insertable dead bolt. Metal drawer, 1/4" Max. material thickness.

OPERATION—Key removable in both locked and unlocked positions.

KEYING—Will key together with all other pin tumbler locks using D4291 key blank except NL-C8700 mail box locks. Available keyed different (**KD**) or keyed alike (**KA**).

KEY BLANK—D4291.

PACKAGING—Supplied with two keys and mounting nut.

FINISHES—26D- Dull Chrome.

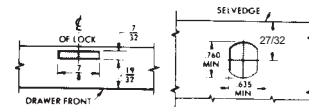

Mounting Holes



Stock #	Mounting or Installation	Bolt Type	Cylinder Length	Bolt Travel	Keyed Alike Number Available
NL-C8137-26D	Drawer	Reinforced, Insertable Dead Bolt	19/32"	7/16"	107, 915

Available **KD**-Keyed Different or **KA**-Keyed Alike. *Specify KD or KA*

CHEST, CUPBOARD & DRAWER LOCKS

PIN TUMBLER DOOR AND DRAWER LOCKS



APPLICATION—For drawers, RH or LH doors. Surface mounted. Requires 57/64" dia. hole for cylinder.

OPERATION—Key removable in both locked and unlocked positions.

KEYING—Will key together with all other pin tumbler locks using D4291 key blank except NL-C8700 mail box locks. Available keyed different (**KD**) or keyed alike (**KA**).

KEY BLANK—D4291.

PACKAGING—Supplied with two keys, strike and mounting screws.

FINISHES—4-Satin Brass, 4G-Antique Brass, 26D- Dull Chrome.

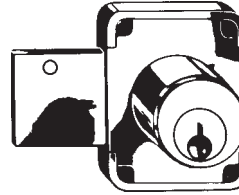
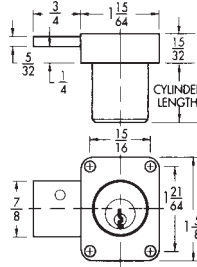

NL-C8173, NL-C8174, NL-C8175

"The Advantage Plus"

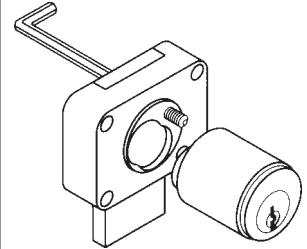

The PLUS feature allows you to remove the cylinder from these pin tumbler box locks while the lock remains in place. Simply use a 5/64" allen wrench from the back.

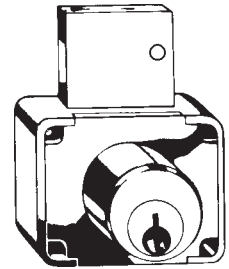
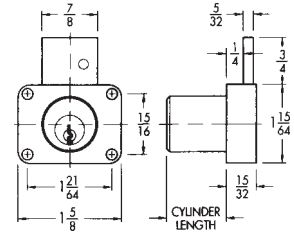

NL-C8177, NL-C8178, NL-C8179

Stock No.	Installation	Bolt Type	Cylinder Length	Bolt Travel	Keyed Alike Numbers Available
NL-C8173-4	Door	Dead	7/8"	3/4"	915
NL-C8173-4G	Door	Dead	7/8"	3/4"	915
NL-C8173-26D	Door	Dead	7/8"	3/4"	107, 915
NL-C8174-26D	Door	Dead	1-1/8"	3/4"	107
NL-C8175-26D	Door	Dead	1-3/8"	3/4"	107, 915
NL-C8177-26D	Drawer	Dead	1-1/8"	3/4"	107
NL-C8178-4	Drawer	Dead	7/8"	3/4"	107
NL-C8178-26D	Drawer	Dead	7/8"	3/4"	103, 107, 915
NL-C8179-4	Drawer	Dead	1-3/8"	3/4"	107
NL-C8179-26D	Drawer	Dead	1-3/8"	3/4"	107, 915

Available **KD**-Keyed Different or **KA**-Keyed Alike. *Specify KD or KA*

PIN TUMBLER DRAWER LOCKS

APPLICATION—For drawers. Surface mounted. Requires 57/64" dia. hole for cylinder.

OPERATION—Key removable in both locked and unlocked positions.

KEYING—Will key together with all other pin tumbler locks using D4291 key blank except NL-C8700 mail box locks. Available keyed different (**KD**) or keyed alike (**KA**).

KEY BLANK—D4291.

PACKAGING—Supplied with two keys and mounting screws.

FINISHES—4-Satin Brass, 26D- Dull Chrome.

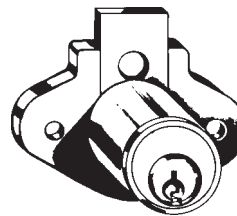

NL-C8163

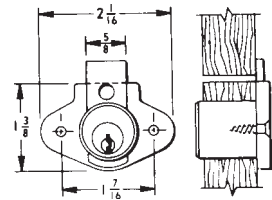

Stock No.	Installation	Bolt Type	Cylinder Length	Bolt Travel	Keyed Alike Number Avail.
NL-C8163-4	Drawer	Dead	15/16"	11/32"	101, 103, 107
NL-C8163-26D	Drawer	Dead	15/16"	11/32"	101, 915

Available **KD**-Keyed Different or **KA**-Keyed Alike. *Specify KD or KA*

"THE ADVANTAGE PLUS" NL-C8163 locks feature easy removal of cylinder from lock housing while lock remains in place. Bolt has access hole for cylinder retention screw at back of lock.

Stock No.

NL-C7163-2C Special Order 3" extension bolt for NL-C8163. Can be cut to required length. 20 per package.

CHEST, CUPBOARD & DRAWER LOCKS

PIN TUMBLER DRAWER LOCKS

CompX
NATIONAL

APPLICATION—Replacement lock housing and cylinder for drawers with 7/8" thick fronts. Half mortise design.

OPERATION—Key removable in both locked and unlocked positions. Interchangeable cylinders are attached or removed through the use of a special key at back of lock.

KEYING—Keyed different (**KD**). 100 changes.

KEY BLANK—D4292 for the NL-C8160.

PACKAGING—NL-C8160 cylinder supplied with two keys. NL-C8161 lock housing supplied with cylinder removal key and mounting screws.

FINISHES—**26**-Bright Brass; **26D**- Dull Chrome.

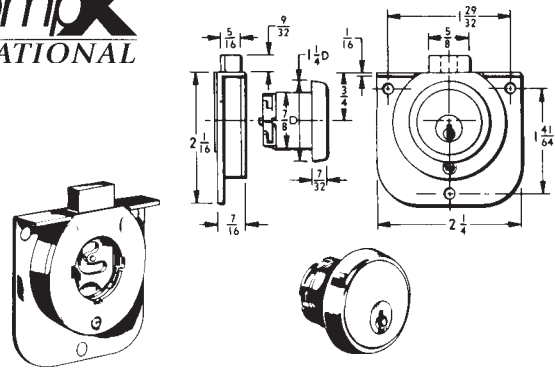

NL-C8161

NL-C8160

Stock #	Mounting or Installation	Bolt Type	Min. Material Thickness	Bolt Travel	Keyed Alike Numbers Available
NL-C8160-26D	In Housing	—	—	—	—
NL-C8161-26	Drawer	Dead	7/8"	9/32"	—

DISC TUMBLER DRAWER LOCKS

APPLICATION—For center drawers of metal desks. Fits special piercing of drawer front and selvage (see drawing). 1/4" max. mat'l. thickness

OPERATION—Key removable in both locked and unlocked positions.

KEYING—Will key together with all other disc tumbler locks using D8785 key blank. Available keyed different (**KD**) or keyed alike (**KA**).

KEY BLANK—D8785.

PACKAGING—Supplied with two keys and mounting nut.

FINISHES—**14A**- Bright Nickel

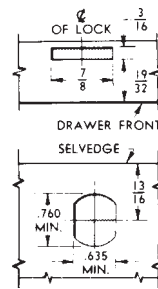

Stock #	Mounting or Installation	Bolt Type	Cylinder Length	Bolt Travel	Keyed Alike Numbers Available
NL-C8701-14A	Drawer*	Reinforced, Insertable Dead Bolt	19/32"	11/32"	C413A, C415A

*Metal drawer, 1/4" max. material thickness.

Available **KD**-Keyed Different or **KA**-Keyed Alike. *Specify KD or KA*

CHEST, CUPBOARD & DRAWER LOCKS

DISC TUMBLER DOOR AND DRAWER LOCKS



APPLICATION—For drawers and doors. Surface mounted. Requires 7/8" dia. hole for cylinder.

OPERATION—Key removable in both locked and unlocked positions, except NL-C8706.

KEYING—Will key together with all other disc tumbler locks using D8785 key blank. Available keyed different (**KD**) or keyed alike (**KA**).

KEY BLANK—D8785.

PACKAGING—Supplied with two keys and mounting screws (NL-C8706 furnished with strike).

FINISHES—**3**-Bright Brass, **4G**-Antique Brass, **14A**- Bright Nickel.

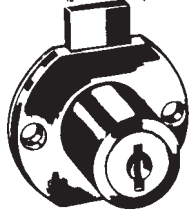
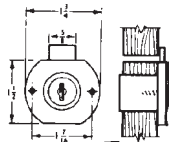

NL-C8703
NL-C8705

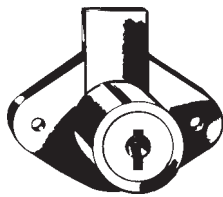
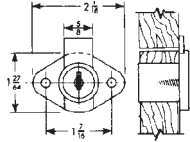

NL-C8803

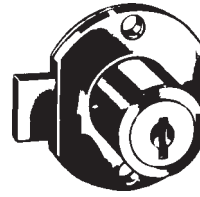
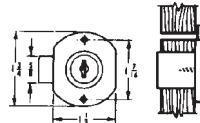

NL-C8704

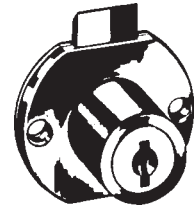
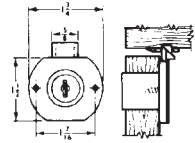

NL-C8706

<u>Stock #</u>	<u>Installation</u>	<u>Bolt Type</u>	<u>Cylinder Length</u>	<u>Bolt Travel</u>	<u>Keyed Alike Numbers Available</u>
NL-C8703-3	Drawer	Dead	15/16"	11/32"	C346A, C413A, C415A, C420A, C642A
NL-C8703-4G	Drawer	Dead	15/16"	11/32"	C346A, C642A
NL-C8703-14A	Drawer	Dead	15/16"	11/32"	C346A, C415A, C420A, C642A
NL-C8704-3	Door	Dead	15/16"	11/32"	C413A, C415A, C642A
NL-C8704-4G	Door	Dead	15/16"	11/32"	C642A
NL-C8704-14A	Door	Dead	15/16"	11/32"	C415A, C642A
NL-C8705-3	Drawer	Dead	1-3/16"	11/32"	C413A, C415A
NL-C8705-4G	Drawer	Dead	1-3/16"	11/32"	C413A, C415A
NL-C8705-14A	Drawer	Dead	1-3/16"	11/32"	C413A, C415A
NL-C8706-3	Drawer	Spring	15/16"	9/32"	C413A, C415A
NL-C8803-3	Drawer	Dead	15/16"	11/32"	C346A, C390A, C413A, C415A, C642A
NL-C8803-4G	Drawer	Dead	15/16"	11/32"	C413A, C415A
NL-C8803-14A	Drawer	Dead	15/16"	11/32"	C346A, C415A, C420A

Available **KD**-Keyed Different or **KA**-Keyed Alike. *Specify KD or KA*

CHEST, CUPBOARD & DRAWER LOCKS



All Timberline Locks consist of two separate components: a lock plug and a cylinder body. A change tool (TB-D500KY) is required to remove lock plugs from the cylinder bodies.

REMOVABLE LOCK PLUG SYSTEM

- Wide selection of locks to fit most furniture & cabinet applications.
- Available in several high quality finishes.
- Removable lock plugs for complete keying versatility.
- Prepackaged in poly-bags for easy distribution to your customer.

These lock plugs will fit in ALL Timberline Locks



<u>Stock No.</u>	<u>Finish</u>
TB-C100LP-14A	Polished Nickel
TB-C200LP-8	Old English
TB-C300LP-19	Black
TB-C400LP-20	Statuary Bronze
TB-C500LP3	Polished Brass

Available Keyed Different (KD) or Keyed Alike (KA): 100T or 105T

DOOR LOCKS



TB-C240CB

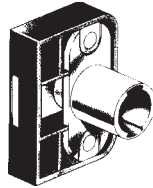

TB-C290CB

APPLICATION—Surface mounted lock for locking doors.
OPERATION—180° key rotation, CCW to lock, key removable in both locked and unlocked positions.
KEYING—Order lock plug separately. (See above)
PACKAGING—Housing is black, toughened nylon. Cylinder is unplated. Cams are zinc plated.

<u>Stock No.</u>	<u>Cam Setback</u>	<u>Cam Extension*</u>	<u>Cam Throw</u>
TB-C240CB	3/32"	15/16"	1/2"
TB-C290CB	9/32"	13/16"	3/8"

*Measured from center of cylinder to tip of cam in unlocked position.

DRAWER LOCKS



TB-C230CB

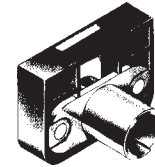

TB-C280CB

APPLICATION—Surface mounted lock for locking drawers.
OPERATION—180° key rotation, CCW to lock, key removable in both locked and unlocked positions.
KEYING—Order lock plug separately. (See above)
PACKAGING—Housing is black, toughened nylon. Cylinder is unplated. Cams are zinc plated.

<u>Stock No.</u>	<u>Cam Setback</u>	<u>Cam Extension*</u>	<u>Cam Throw</u>
TB-C230CB	3/32"	15/16"	1/2"
TB-C280CB	9/32"	13/16"	3/8"

*Measured from center of cylinder to tip of cam in unlocked position.

CAM LOCK KIT—TB-C165CB

APPLICATION—Universal type lock for either doors or drawers. Kit contains a variety of easily switched cams to accommodate most locking situations.
OPERATION—90° key rotation, CCW to lock.
KEYING—Order lock plug separately. (See above)
PACKAGING—Cylinder supplied with two straight cams and two bent cams. Cylinder is unplated. Cams are zinc plated.

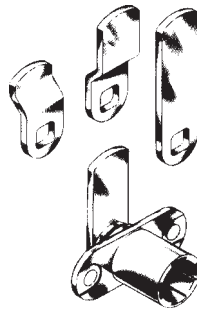

<u>Stock No.</u>	<u>Description</u>
TB-C165CB	Cam Lock Kit

This kit will replace the following Timberline cam locks:

<u>90° Rotation</u>		<u>180° Rotation</u>	
CB-080	CB-090	CB-180	CB-190
CB-083	CB-093	CB-183	CB-193
CB-084	CB-094	CB-184	CB-194
CB-085	CB-095	CB-185	CB-195
CB-087	CB-097	CB-187	CB-197
CB-088	CB-098	CB-188	CB-198

Need a lock not shown here?? Then just give us a call 1-800-848-1577.

©ZIPF LOCK COMPANY

Also be sure to check "DESKS LOCK" if you cannot find it here.

CHEST, CUPBOARD & DRAWER LOCKS

TWO DRAWER SIDE GANG LOCK—TB-D270CB

APPLICATION—Two drawer gang lock for locking two pedestal drawers with a single lock. Lock mounts on side of cabinet.

OPERATION—180° key rotation, CCW to lock. Key removable in both locked and unlocked position.

KEYING—Order lock plug separately. (See previous page)

PACKAGING—Housing supplied with two C500DC-19 Drawer Clips. Housing is black, toughened nylon. Cylinder is unplated. Cams are zinc plated.

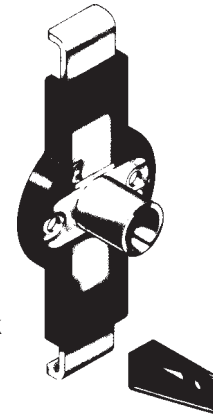

<u>Stock No.</u> TB-D270CB	<u>Description</u> Side Gang Lock
-------------------------------	--------------------------------------

DOUBLE DOOR LOCKS

APPLICATION—Surface mount lock for locking two adjacent doors. Eliminates the need for a spring catch on the door opposite the lock. Works with either overlay or inset doors.

OPERATION—180° key rotation, CCW to lock. Key removable in both locked and unlocked position.

KEYING—Order lock plug separately. (See previous page)

PACKAGING—Supplied with two strike plates as shown. Housing is black, toughened nylon. Cylinder is unplated. Cams are zinc plated.

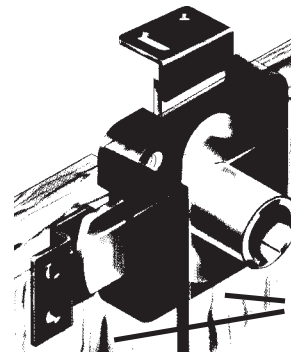

<u>Stock No.</u> TB-C250CB	<u>Description</u> Double Door Lock
-------------------------------	--

Top Cam Setback: 3/16"
 Top Cam Extension*: 29/32"
 Side Cam Setback: 3/32"
 Side Cam Extension*: 29/32"
 Cam Throw: 1/2"

*Measured from center of cylinder to tip of cam in unlocked position.

Locks both doors without the use of a spring catch.

THICK PANEL LOCK

APPLICATION—Universal type lock for either doors or drawers that can accommodate panel thickness from 7/8" to 1-3/8" thick.

OPERATION—90° key rotation, CCW to lock.

KEYING—Order lock plug separately. (See previous page)

PACKAGING—Housing supplied with straight cam and bent cam. Housings are unplated. Cams are zinc plated.

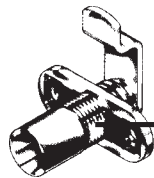

<u>Stock No.</u> TB-C170CB	<u>Description</u> Thick Panel Lock
-------------------------------	--

Mounting flange adjust to allow lock to be mounted in panels from 7/8" thick up to 1-3/8" thick.

PUSH LOCK

APPLICATION—For locking sliding, bypass type doors. Requires 3/4" hole in front door for cylinder.

OPERATION—Pushing in cylinder locks doors, with or without key. 45° key rotation allows cylinder to pop back out to unlock doors. Key removable in both locked and unlocked positions.

KEYING—Order lock plug separately. (See previous page)

PACKAGING—Supplied with nickel plated finished cup as shown. Housing is black, toughened nylon.

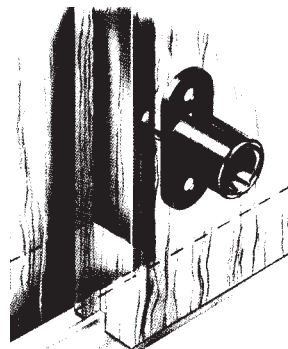

<u>Stock No.</u> TB-C175CB	<u>Description</u> Push Lock
-------------------------------	---------------------------------

CHEST, CUPBOARD & DRAWER LOCKS



GANG LOCK CYLINDER BODY

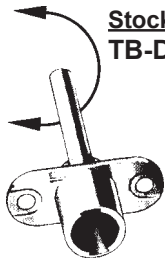

Stock No.
TB-D100CB

Description
For Front Mount Systems

*See previous page
for lock plugs.*

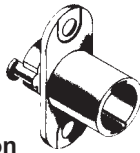

Stock No.
TB-D150CB

Description
For Side Mount Systems

BEZELS

- Allows cylinder bodies to be used with 3/4" through 7/8" diameter holes and permits use of locks in 7/8" thick panels.



Stock No.
TB-C100BZ-14A
TB-C200BZ-8
TB-C300BZ-19
TB-C400BZ-20
TB-C500BZ-3

Finish
Bezel Nickel
Bezel Old English
Bezel Black
Bezel Statuary Bronze
Bezel Brass

STRIKE PLATES



TB-C100SP-19



TB-C101SP-19

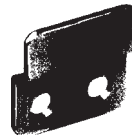

TB-C257SP-19

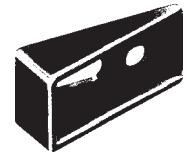

TB-C500DC-19



TB-C185SP-19

TOOLS



TB-C165DB
16.5mm Drill Bit



TB-D500KY
CHANGE TOOL
This tool required to remove lock plugs from cylinder bodies.