

CAM LOCKS

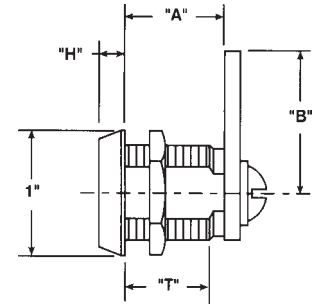

DOUBLE BITTED CAM LOCKS

- Eleven crisscross blade tumbler plug in 3/4" diameter.
- Die Cast barrel with two flats—5/8" across.
- Key and cam rotation 90° from locked (12 O'clock) to unlocked (3 O'clock) position with keypull in locked position only.
- Straight cam furnished is 1/8" thick x 3/4" wide.
- Standard finish: Polished Nickel.
- Two keys furnished per lock.

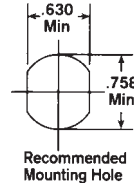

1801 Series

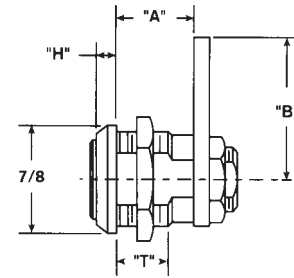

3186, 3205 Series

Stock No.	A	B	H	I	Keyed Alike Numbers Available
C1801	13/16"	1-1/8"	13/64"	11/16"	2001 (No KD)
C1802	1-1/16"	1-1/8"	13/64"	15/16"	2001 (No KD)
C1804	1-1/2"	1-1/8"	13/64"	1-13/32"	2001 (No KD)
C3186	5/8"	1-1/8"	5/32"	13/32"	2001, 2007
C3205	7/16"	1-1/8"	13/64"	15/64"	2001, 2007

Most Locks available **KV***-Keyed Different or **KA**-Keyed Alike.

Specify KD or KA

*KV indicates the majority of the quantity of locks will be keyed different. A lesser quantity will potentially be keyed alike to one or more key numbers. We can not guarantee that we can ship keyed DIFFERENT locks.

ACE II® 7 PIN TUMBLER CAM LOCKS

- All brass construction.
- Patented Ace II® assembly.
- Center plug contains anti-drill pin for added security.
- Furnished with straight locking cams which can be mounted vertically or horizontally and also a 1/4" offset cam. Cams are 1/8" thick x 3/4" wide..
- Standard finish: Polished Nickel.
- Two keys furnished per lock.

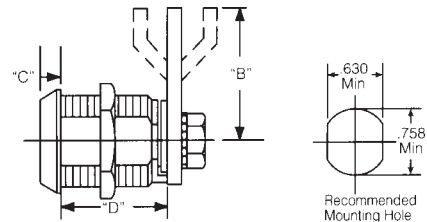

Stock No.	B	C	D	Keyed Alike Numbers Available
C4152	1-1/8"	13/64"	15/16"	PL505, PL910, 6022*
C4153	1-1/8"	1/4"	11/16"	PL505, PL910, 6234, 6030*
C4160	1-1/8"	13/64"	1-3/32"	6234, PL960*

*These keyed alike numbers are discontinued—limited supply.

Most Locks available **KD**-Keyed Different or **KA**-Keyed Alike. **Specify KD or KA**

Key rotation/Removal is determined by the STOP CAM you select and how it is positioned. A) 180° clockwise rotation-key removal at 12 O'clock; B) 180° counter clockwise rotation-key removal at 12 O'clock; C) 90° clockwise rotation-key removal at 12 & 3 O'clock; D) 90° counter clockwise rotation-key removal at 12 & 9 O'clock;

©ZIPF LOCK COMPANY

CAM LOCKS



1000 SERIES HIGH SECURITY GEM CIRCULAR K137 KEYWAY

- 7 pin tumbler.
- Multi-function.
- Standard finish: Nickel Plated.
- Two keys furnished per lock.

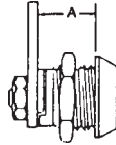

Contains:	
Lock	90° Stop Washer
Wonder Washer	Straight Cam
Spur Washer	1/4" Bent Cam
3/4" Nut	Cam hole adapter
180° Stop Washer	Screw

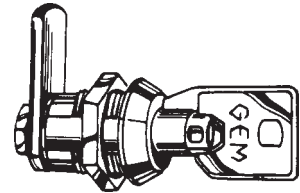

Stock No.	A	Keyed Alike Numbers Available
MFW-1038	1/2"	27379, 27380, 27381, 27382, 27383, 27384, 27385
MFW-1058	23/32"	27379, 27380, 27381, 27382, 27383, 27384, 27385
MFW-1078	15/16"	27379, 27380, 27381, 27382, 27383, 27384, 27385
MFW-1118	1-5/32"	27379, 27380, 27381, 27382, 27383, 27384, 27385
MFW-1148	1-1/2"	27379, 27380, 27381, 27382, 27383, 27384, 27385

Most Locks available **KD**-Keyed Different or **KA**-Keyed Alike. **Specify KD or KA**

Keyed Different— Locks ordered KD will be supplied with random keying. Some duplication of codes is possible.

23000 SERIES CAM LOCKS SINGLE BITTED

- Single bitted.
- Universal Keyway—K54G.(See next page)
- Multi-function
- Finish: Stainless Steel or brass.
- Two keys furnished per lock.

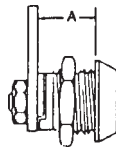

Contains:	
Lock	90° Stop Washer
Wonder Washer	Straight Cam
Spur Washer	1/4" Bent Cam
3/4" Nut	Spline Fillers
180° Stop Washer	Screw

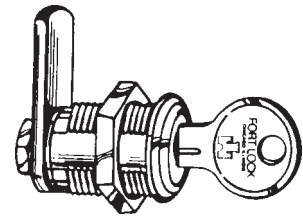

STAINLESS STEEL FINISH

Stock No.	A	Keyed Alike Numbers Available
MFW-23038	7/16"	217, 221, 224, 237, 238
MFW-23058	5/8"	217, 221, 224, 237, 238
MFW-23078	7/8"	217, 221, 224, 237, 238
MFW-23118	1-1/8"	217, 221, 224, 237, 238
MFW-23138	1-3/8"	217, 221, 224, 237, 238
MFW-23168	1-3/4"	217, 221, 224, 237, 238

BRASS FINISH

Stock No.	A	Keyed Alike Numbers Available
MFW-23038B	7/16"	217, 221
MFW-23058B	5/8"	217, 221
MFW-23078B	7/8"	217, 221
MFW-23118B	1-1/8"	217, 221
MFW-23138B	1-3/8"	217, 221
MFW-23168B	1-3/4"	217, 221

Most Locks available **KD**-Keyed Different or **KA**-Keyed Alike. **Specify KD or KA**

Keyed Different— Locks ordered KD will be supplied with random keying. Some duplication of codes is possible.

2" STRAIGHT CAMS

Stock No.	"A"	For
SF3200 2"	2"	Flat Lock
SG3200 2"	2"	Gem Lock

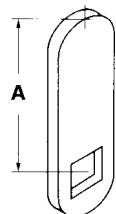

**Need a COMPX product not in our catalog??
Just give us a call with your needs !!**



©ZIPF LOCK COMPANY

CAM LOCKS



29000 SERIES HIGH SECURITY DOUBLE BITTED CAM LOCKS

- Double Bitted—5 tumblers.
- Keyway: K775
- Multi-function.
- Standard finish: Stainless Steel.
- Two keys furnished per lock.

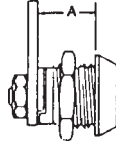

Contains:	
Lock	90° Stop Washer
Wonder Washer	Straight Cam
Spur Washer	1/4" Bent Cam
3/4" Nut	Spline Fillers
180° Stop Washer	Screw

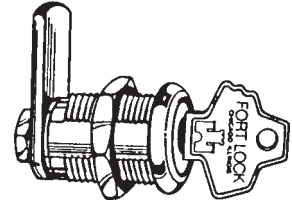

Stock No.	A	Keyed Alike Numbers Available
MFW-29058	5/8"	D3012, D3045, D3059, D3085, D3165
MFW-29078	7/8"	D3012, D3045, D3059, D3085, D3165
MFW-29118	1-1/8"	D3012, D3045, D3059, D3085, D3165
MFW-29138	1-3/8"	D3012, D3045, D3059, D3085, D3165

"Floating" tumblers-cylinder turns slightly and wedges tumblers into a secondary double locked position if picking is attempted. Key will realign tumblers when used.

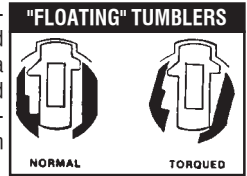

Most Locks available **KD**-Keyed Different or **KA**-Keyed Alike. **Specify KD or KA**

Keyed Different— Locks ordered KD will be supplied with random keying. Some duplication of codes is possible.

The Concept of Multi-Function:

The concept of Multi-Function is to make one bag of components available to produce many different functioning locks (up to 6 different functions in Fort's single bitted bag). This enables the locksmith to carry fewer locks in inventory while still have complete stock on hand. Multi-Function bagged cam locks include Fort's patented Wonder Washer, which allows for installation into either wood or metal without the use of a double "D" punch.

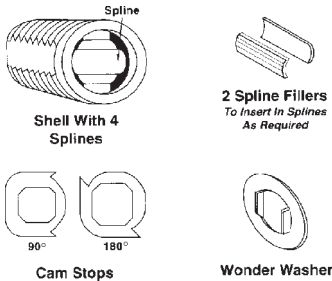

LOCKS PROVIDED WITH PARTS FOR SIX DIFFERENT FUNCTIONS				
Function	Key Rotation	Key Removeable at:	Parts Used	
			Cam Stop	Spline Filler Placed at:
1	12-3 CW	12	90° RT	3:00 & 9:00
2	12-3 CW	12, 3	90° RT	—
3	12-6 CW	12, 6	180° RT	3:00 & 9:00
4	12-9 CCW	12	90° LFT	9:00 & 3:00
5	12-9 CCW	12, 9	90° LFT	—
6	12-9 CCW	12, 6	180° LFT	9:00 & 3:00

UNIVERSAL KEYING MATRIX

Fort's 23000 series cam locks are designed with the Universal Keyway which accepts many other manufacturers' key blanks and will operate with their key code systems. (See chart at right)

This is important when you have another manufacturer's locking system in the field and you wish to build onto that existing system by adding locks made by Fort Lock and still use the same existing keys.

MFG.	Key Code	MFG.	Key Code	MFG.	Key Code
All-Lock	PK502-999	LLMK	ALxxx	Hurd	LL201H-LL225H
CCL	AMxxx codes	ESP	ES101-204		LL201H-LL225H ^S
Chicago	FAB24		SL342		2077-2099 ^S
	LL226-LL275		UC380		2051-2101
	W1000-W1050 ^E	Hudson	HL-201-400	Ilco	GH067
	W1000-		HC714-840	Lori	603
W1050 ^{ES}	LL61-LL139		MM750-999	National	EB1-240
	LL61-LL139 ^S	Hurd	HL959		C001A-633A
	LL331		2001-2050		D127A
	1250-1499		2001-2050 ^S		

^E Even numbers
^S Sears

CAM LOCKS

PIN TUMBLER CYLINDER CAM LOCKS—BRASS CONSTRUCTION



Cam Dimensions

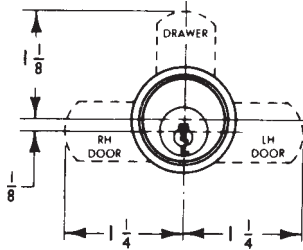

Through the use of a shifter, the 360° key turn turns the cam 90° in either direction. Actual application determines which cam position is the locked position. Each lock is furnished with an alternate cam for opposite cam turn

Applications: solid lines show locked position of cam	Position of shifter on back of lock	Applications: solid lines show locked position of cam	Position of shifter on back of lock

**LIPPED/
OVERLAY**
NL-C8103
NL-C8109

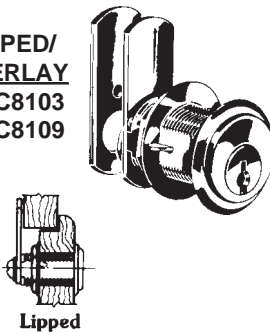

APPLICATION—For drawers, RH or LH doors. NL-C8103 and NL-C8109 are for lipped or overlay construction. For overlay application, the combined thickness of front and frame cannot exceed the cylinder length. Also see overlay detail below. The other locks are for flush applications.

OPERATION—90° cam turn, key removable in both locked and unlocked positions.

KEYING—Will key together with all other pin tumbler locks using D4291 key blank except NL-C8700 series mail box locks. See table for available keying.

KEY BLANK—D4291.

FINISH—4-Satin Brass, 26D-Dull Chrome (Brushed)

PACKAGING—Supplied with two keys, trim washer, spur washer for wood, mounting nut and two cams.

FLUSH
NL-C8106
NL-C8108

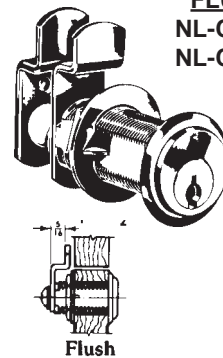

The NL-C8102, is a Multi-Functional Pin Tumbler cam lock with a 1-1/16" cylinder length. The lock is packaged with four (4) cams, two straight and two double formed. This allows the lock to be used for multiple applications for either drawer or right hand/left hand with lipped or overlay construction.

Stock No.	Type of Mounting	Cylinder Length	Maximum Material Thickness	Finishes	Keyed Alike Numbers Available
NL-C8102	Flush	1-1/16"	3/4"	4, 26D	107, 915
NL-C8103	Lipped/Overlay	1-3/16"	7/8"	4, 26D	4-107, 26D-101, 107, 915
NL-C8106	Flush	1-7/16"	1-1/8"	4, 26D	4-107, 26D-107, 915
NL-C8108	Flush	1-3/4"	1-3/8"	4, 26D	107, 915
NL-C8109	Lipped/Overlay	1-3/4"	1-1/2"	4, 26D	4-107, 26D-107, 915

Most Locks available **KD**-Keyed Different or **KA**-Keyed Alike. *Specify KD or KA*

Combi-Cam™

The Best Combined Cam Lock on the Market!

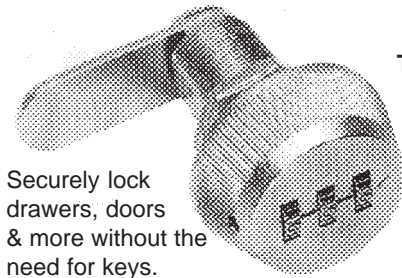

Securely lock drawers, doors & more without the need for keys.

Cam Lock—(Chrome)

Stock No.	Length
CC-7850L	1-1/8"
CC-7850M	7/8"
CC-7850S	5/8"

No Keys to Hassle With!!

The Combi-Cam is a secure solid metal cam lock with 1,000 possible combinations. Best of all, unlike the competition, it requires no expensive kits nor the arduous task of entirely taking apart the lock replacing disks!

Changing the combination is simple. With the lock set on the opening combination, push in the reset button while setting the new combination. IT IS THAT EASY!

Great product for when keys are a hassle or when frequent lock changes are needed!!

Accessories—

Stock No.	Description
CC-7850-FP	Finger Pull
CC-7850-OC	2" offset cam

CAM LOCKS

DISC TUMBER CYLINDER CAM LOCKS



Mounting Holes for all Cam Locks

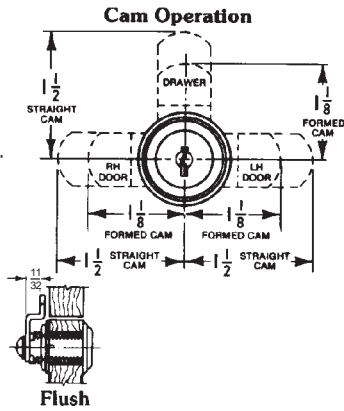
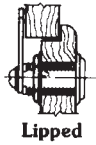
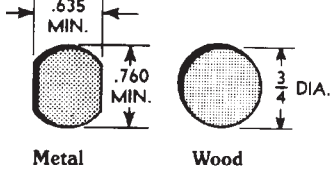

APPLICATION—For drawers, RH or LH doors with lipped / overlay construction (straight cam) or flush construction (formed cam). For overlay application, the combined thickness of front and frame cannot exceed the cylinder length. Also see overlay detail below.

OPERATION—90° cam turn on all locks. Key removable in both locked and unlocked positions.

KEYING—Will key together with all other disc tumbler locks using D8785 key blank. Available keyed alike or keyed different. See keyed alike numbers below.

KEY BLANK—D8785

FINISH—3-Bright Brass, 4G-Antique Brass, 14A-Bright Nickel

PACKAGING—Supplied with two keys, trim washer, spur washer for wood, mounting nut and two cams.

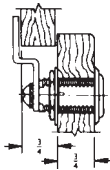

OVERLAY

Stock No

NL-C7014-2C Cam

The NL-C8053 lock using the NL-C7014-2C cam (order separately) accommodates overlay construction using a 3/4" thick front and 3/4" thick frame. 1-5/8" long.

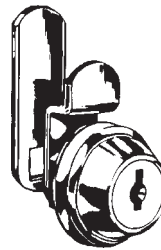

NL-C8051

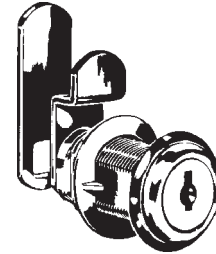

NL-C8052, NL-C8053
NL-C8054, NL-C8055

Locks furnished with straight cam assembled.

Stock#	Type of Mounting	Cylinder Length	Maximum Material Thickness	Finishes	Keyed Alike Numbers Available
NL-C8051		7/16"	7/64"	3, 14A	See chart below
NL-C8052	Lipped/Overlay	5/8"	15/64"	3, 14A	See chart below
NL-C8053	or	1-3/16"	7/8"	3, 4G, 14A	See chart below
NL-C8054	Flush	15/16"	5/8"	3, 4G, 14A	See chart below
NL-C8055		1-7/16"	1-1/8"	3, 14A	See chart below

Most Locks available **KD**-Keyed Different or **KA**-Keyed Alike. **Specify KD or KA**

KEYED ALIKE NUMBERS AVAILABLE:

- NL-C8051-3 C413A
- NL-C8051-14A C346A, C413A, C415A, C642A
- NL-C8052-3 C346A, C413A, C415A
- NL-C8052-14A C346A, C413A, C415A, C420A, C642A
- NL-C8053-3 C346A, C390A, C413A, C415A, C642A
- NL-C8053-4G C346A, C390A, C415A, C642A
- NL-C8053-14A C346A, C390A, C413A, C415A, C420A, C642A
- NL-C8054-3 C413A, C415A
- NL-C8054-4G C413A
- NL-C8054-14A C346A, C390A, C413A, C415A, C420A, C642A
- NL-C8055-3 C346A, C390A, C413A, C415A, C420A, C642A
- NL-C8055-14A C346A, C413A, C415A, C420A, C642A

CAM LOCKS

DISC TUMBLER CYLINDER CAM LOCKS WITH FLEXAFUNCTION



Mounting Holes for all Cam Locks

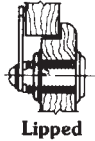
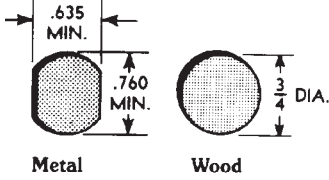

Cam Operation

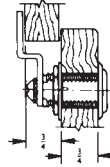
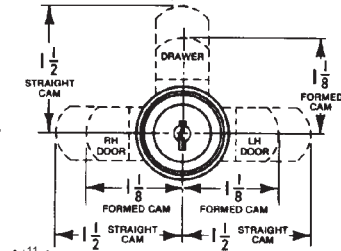

OVERLAY

Stock No

NL-C7014-2C Cam

The NL-C8073 lock using the NL-C7014-2C cam (order separately) accommodates overlay construction using a 3/4" thick front and 3/4" thick frame. 1-5/8" long.

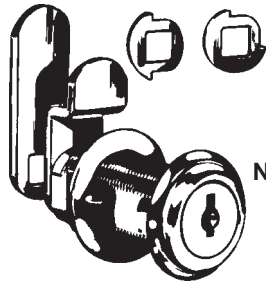

NL-C8060, NL-C8073, NL-C8075

Assembled with straight cam and 90° cam rotation

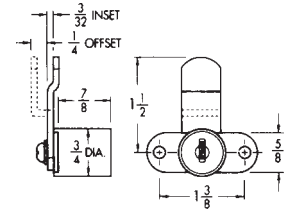
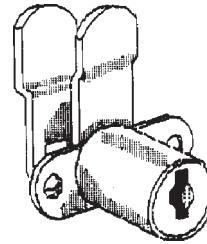

NL-C8080

Assembled for 90° cam turn

APPLICATION—For drawers, RH or LH doors with lipped /overlay construction (straight cam) or flush construction (formed cam). For overlay application, the combined thickness of front and frame cannot exceed the cylinder length. Also see overlay detail above.

OPERATION—Choice of either 90° or 180° cam turn. Key removable in both locked and unlocked positions.

KEYING—Will key together with all other disc tumbler locks using D8785 key blank. Available keyed alike or keyed different. See keyed alike numbers below.

KEY BLANK—D8785

FINISH—3-Bright Brass, 4G-Antique Brass, 14A-Bright Nickel

PACKAGING—Supplied with two keys, trim washer, spur washer for wood, mounting nut, two cams and two stop washers.

APPLICATION—For doors and drawers. Surface mounted. Requires 3/4" dia. hole for cylinder.

OPERATION—Choice of either 90° or 180° cam turn. Key removable in both locked and unlocked positions.

KEYING—Will key together with all other disc tumbler locks using D8785 key blank. Available keyed alike or keyed different. See keyed alike numbers below.

KEY BLANK—D8785

FINISH—3-Bright Brass, 4G-Antique Brass, 14A-Bright Nickel

PACKAGING—Supplied with two keys, two mounting screws, two formed cams and two stop washers. Assembled for 90° cam turn.

Stock#	Type of Mounting	Cylinder Length	Maximum Material Thickness	Finishes	Keyed Alike Numbers Available
NL-C8060	Lipped/	1-3/4"	1-7/16"	3, 4G, 14A	See chart below
NL-C8073	Overlay	1-3/16"	7/8"	3, 4G, 14A	See chart below
NL-C8075	or	1-7/16"	1-1/8"	3, 14A	See chart below
NL-C8080	Flush	7/8"	7/8"	3, 4G, 14A	See chart below

Most Locks available **KD**-Keyed Different or **KA**-Keyed Alike. *Specify KD or KA*

KEYED ALIKE NUMBERS AVAILABLE:

NL-C8060-3 C415A
 NL-C8060-4G C413A, C415A
 NL-C8060-14A C346A, C390A, C415A
 NL-C8073-3 C346A, C390A, C415A, C642A
 NL-C8073-4G C390A, C415A, C642A
 NL-C8073-14A C346A, C390A, C413A, C415A, C420A, C642A

NL-C8075-3 C390A, C413A, C415A, C420A
 NL-C8075-14A C346A, C390A, C413A, C415A, C420A, C642A
 NL-C8080-3 C390A
 NL-C8080-4G C413A
 NL-C8080-14A C346A

CAM LOCKS

TRUCK BODY UTILITY TOOL BOX PLUNGER LOCK

- 5 wafer tumbler cylinder.
- Regularly furnished with 1 key, ES8 keyblank.
- Standard package includes 2 locks KA with 2 keys.
- Regularly furnished with 3/4-24 mounting nut.
- Standard replacement for Contico and Delta Truck Body tool boxes.

Stock No.
ES-1062STD

• **Operation** — Key turns 90° CW allowing spring loaded plunger to be depressed for striking action. Plunger returns to starting position when pressure is released. Key is removable in locked and unlocked position.

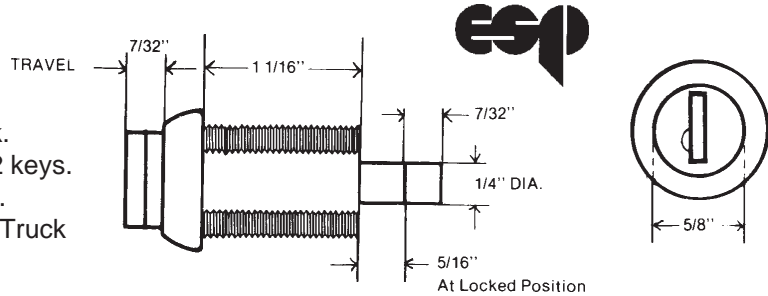

SINGLE BITTED CAM LOCKS

- Single bitted.
- IN8 Keyway.
- Finish: Stainless Steel or brass.
- Two keys furnished per lock.



Contains:
Lock 90° Stop Washer
Cylinder Ring Straight Cam
Spur Washer 1/4" Bent Cam
3/4" Nut 1/4" Nut
180° Stop Washer

STAINLESS STEEL FINISH

Stock No.	A	Keyed Alike Numbers Available
JT-CM7161	7/16"	330, 331, 332, 334
JT-CM0581	5/8"	330, 331, 332, 334
JT-CM0781	7/8"	330, 331, 332, 334
JT-CM1181	1-1/8"	330, 331, 332, 334
JT-CM1381	1-3/8"	330, 331, 332, 334
JT-CM1341	1-3/4"	330, 331, 332, 334

BRASS FINISH

Stock No.	A	Keyed Alike Numbers Available
JT-CM0582	5/8"	330
JT-CM0782	7/8"	330
JT-CM1182	1-1/8"	330
JT-CM1382	1-3/8"	330

Most Locks available **KD**-Keyed Different or **KA**-Keyed Alike. *Specify KD or KA*

TUBULAR CAM LOCKS

- Two keys furnished per lock.

Contains:
Lock 90° Stop Washer
Spur Washer(2) Straight Cam
3/4" Nut 1/4" Bent Cam
180° Stop Washer 1/4" Nut



THUMBTURN CAM LOCKS

CHROME FINISH

Stock No.	A
JT-TT0781	7/8"

Contains:
Lock
Spur Washer
3/4" Nut
90° Stop Washer
Straight Cam
1/4" Bent Cam
Screw



CHROME FINISH

Stock No.	A	Keyed Alike Numbers Available
JT-TB11161	11/16"	1248,0759,7901
JT-TB15161	15/16"	1248,0759,7901
JT-TB19161	1-3/16"	1248,0759,7901
JT-TB23161	1-7/16"	1248,0759,7901

CONVERSION CHART

Jet	Fort	All-Lock	CCL	Chicago	ESP	National
CM7161	MFW23038	C8199			437	C8051
CM0581, 2	MFW23058	C8499	15751	C1725	625	C8052
CM0782, 2	MFW23078	C8599	15752	C1701	875	C8053
CM1181, 2	MFW23118	C8699	15753	C1702	1125	C8054
CM1381, 2	MFW23138	C8799	15760	C1704	1375	C8055
CM1341	MFW23168		15259			C8060
TT0581	MFWTT058				TT625STD	
TT0781	MFWTT078				TT875STD	
TT1181					TT1125STD	
TB11161	MFW1058	C7100		4153		
TB15161	MFW1078	C7200		4152		
TB19161	MFW1118	C7300		4160		
TB23161	MFW1148	C7400		4160-25		

We also stock Jet's Desk Locks, Showcase Locks, Drawer Locks, Mail Box Locks, File Cabinet Locks

©ZIPF LOCK COMPANY