

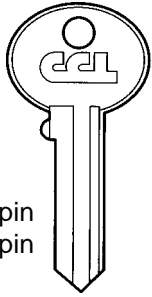



ORIGINAL CYLINDER KEY BLANKS

CCL key blanks are discontinued. Please check Iico (pg. 1032-1033) or Jet (pg. 1078-1079)



8632C 4 pin
8618C 5 pin

SECTION	KEY BLANK NO.
	8632C-CR 8618C-CR
	8632C-CL 8618C-CL
	8632C-VR 8618C-VR
	8632C-VL 8618C-VL

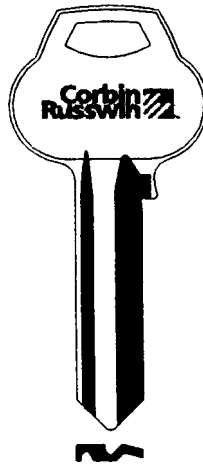

L4-6PIN-10

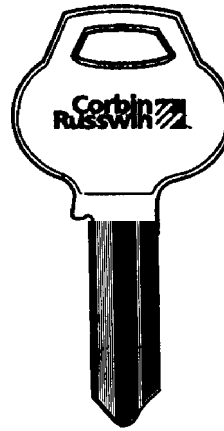

752-5PIN-10

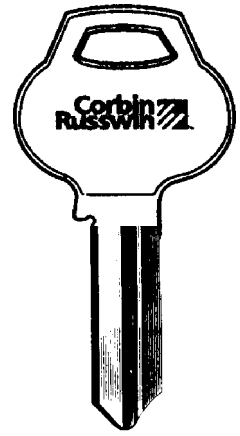





852-5PIN-10

CCL



CORBIN/RUSSWIN



 27-5PIN-10 5 pin
 27-6PIN-10 6 pin

 77-5PIN-10 5 pin
 77-6PIN-10 6 pin

 97-5PIN-10 5 pin
 97-6PIN-10 6 pin

 67-5PIN-10 5 pin
 67-6PIN-10 6 pin
 99-5PIN-10 5 pin



NOTE: Factory order only
Call for quote.

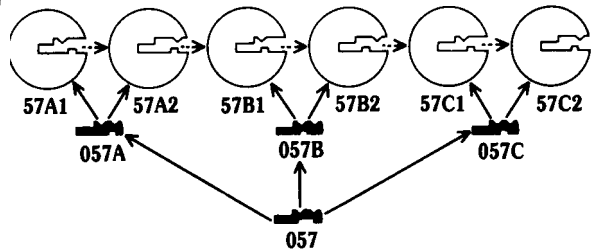

Plug sections are shown in circles. Key sections are shown shaded. All shaded sections are Master Key. Arrows indicate master key control.

CORBIN/RUSSWIN

10-Nickel Silver

59A1-5PIN-10
59A1-6PIN-10

59B1-5PIN-10
59B1-6PIN-10

59C1-6PIN-10

59D1-6PIN-10

59A2-5PIN-10
59A2-6PIN-10

59B2-5PIN-10
59B2-6PIN-10

59C2-6PIN-10*

59D2-6PIN-10

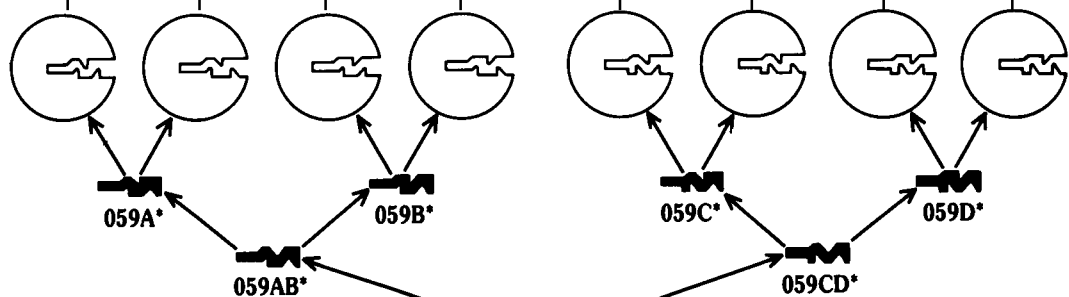
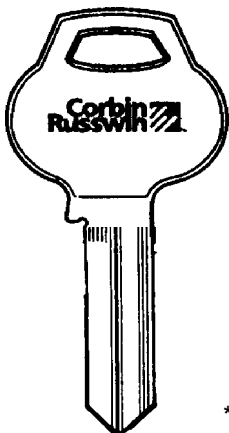

*NOTE: Factory order only
Call for quote .

Plug sections are shown in circles. Key sections are shown shaded. All shaded sections are Master Key. Arrows indicate master key control.

CORBIN/RUSSWIN

ORIGINAL CYLINDER KEY BLANKS

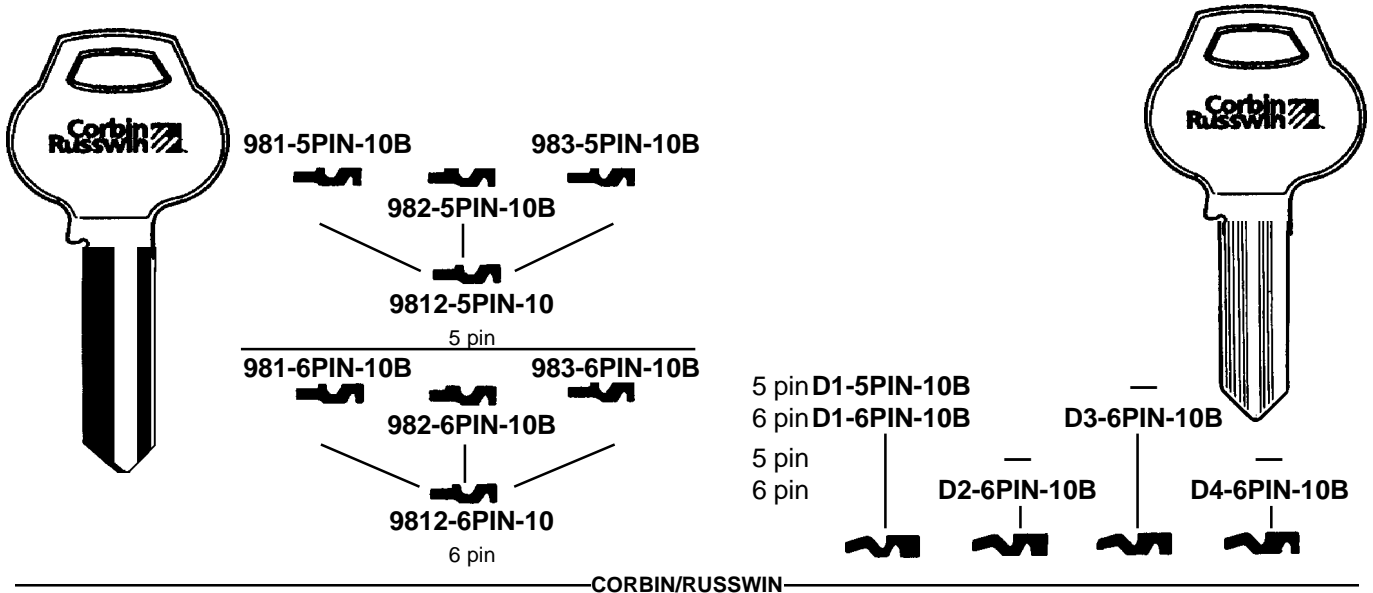

NOTE: Fort blanks may not be actual size.

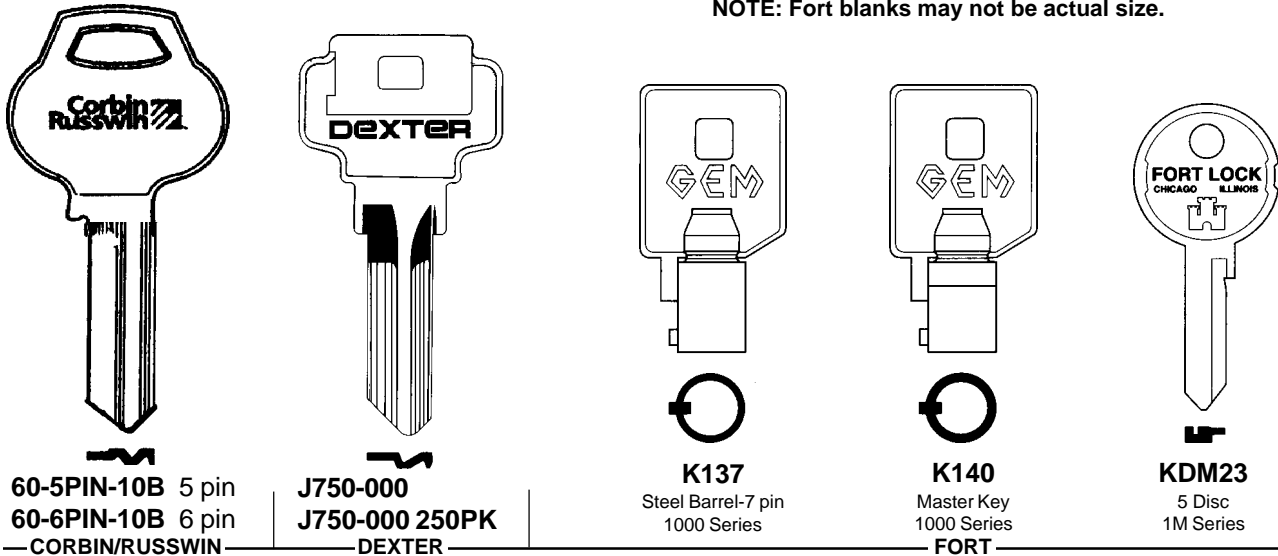

NOTE: Fort blanks may not be actual size.

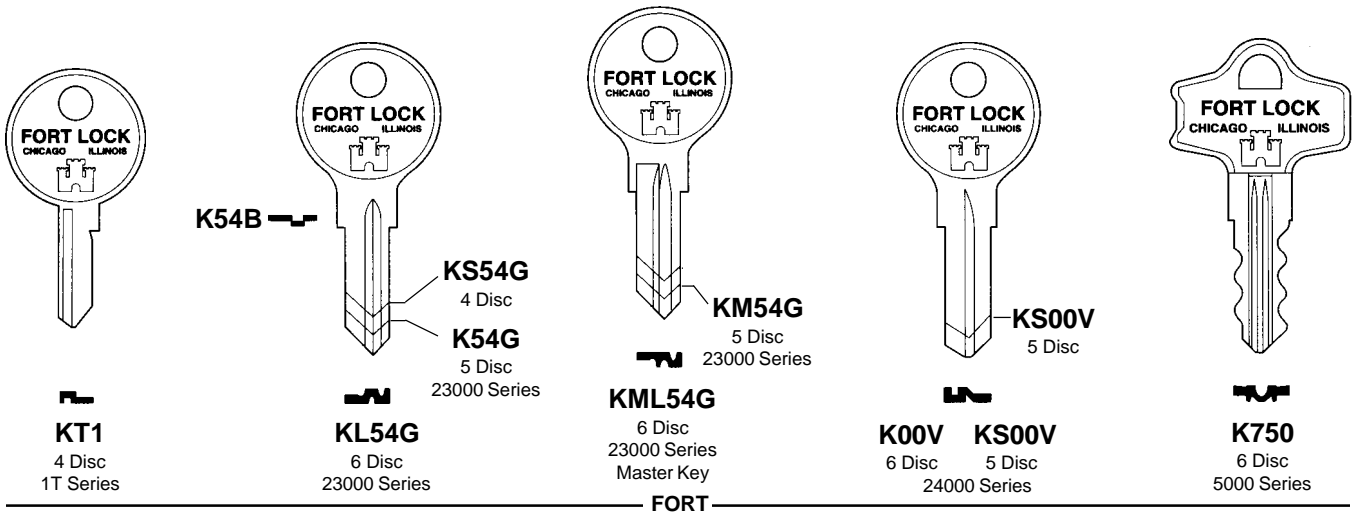

ESP CYLINDER KEY BLANKS



AB1

ABUS LOCKS



AM1

AMERICAN JUNKUNC



AM3

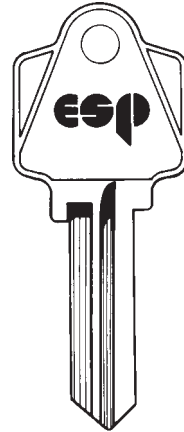

AR1

ARROW LOCKS



AR4

6 pin

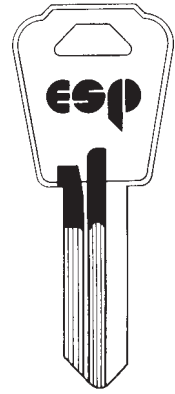

NH1

BROOK NATIONAL

BOMMER — SEE HUDSON

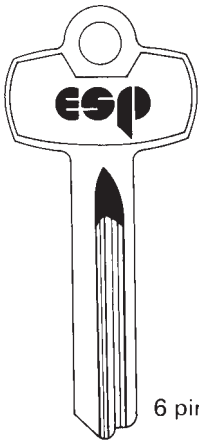

BE2

BEST LOCKS



BN1

BARGMAN LOCKS



BN7



AP101

AP102
AP103
AP104



CG1

CHICAGO LOCKS



CG2



CG3



CG6

CHICAGO LOCKS



CG16



CO1

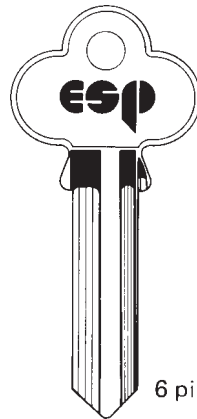

CO2

CORBIN LOCKS



CO3

6 pin

ESP CYLINDER KEY BLANKS

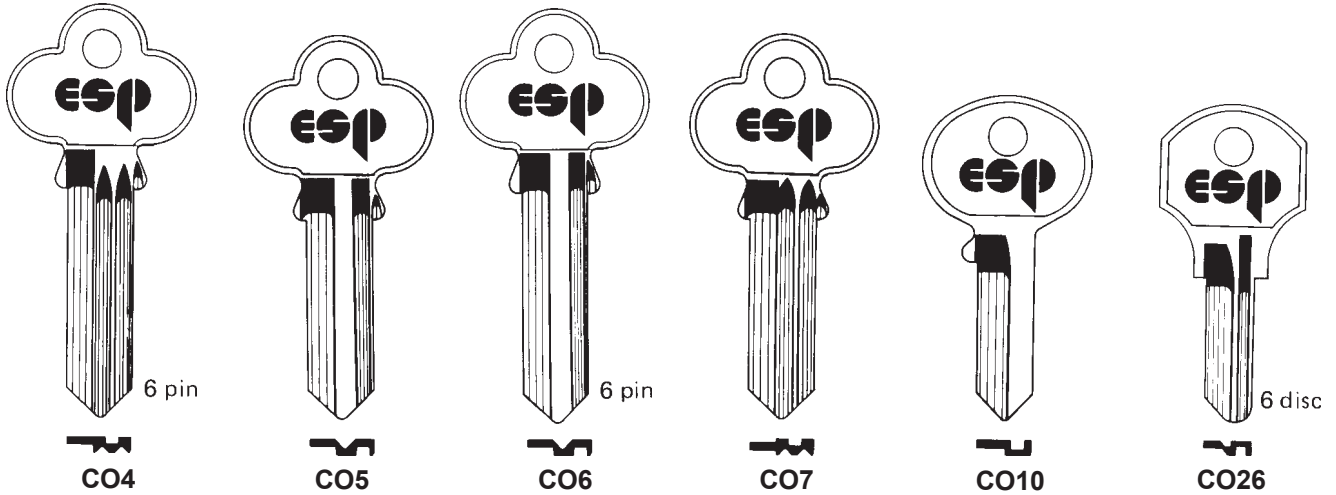

CORBIN LOCKS

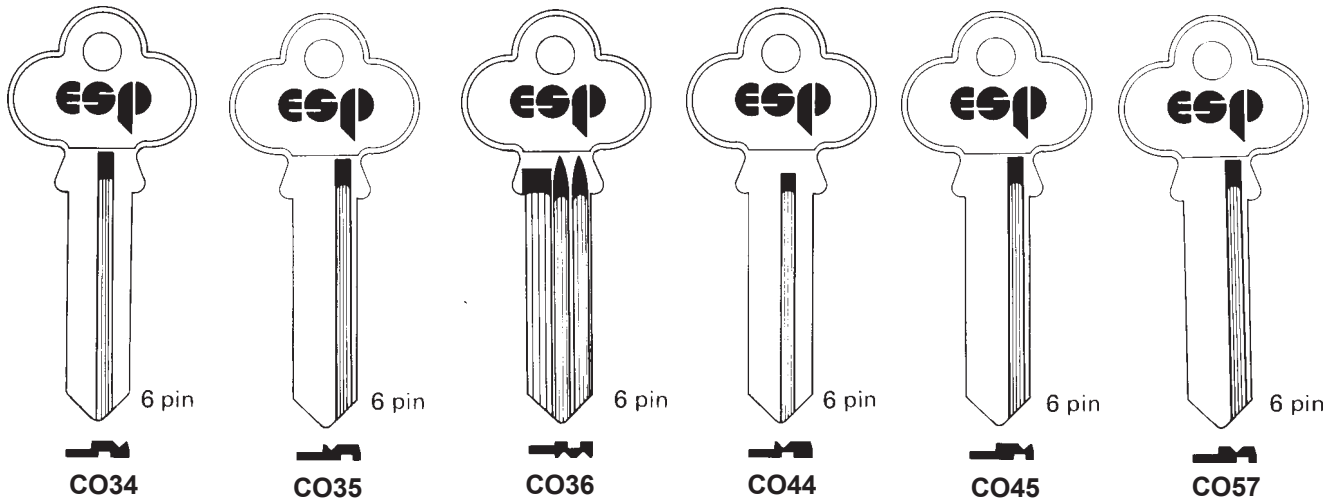

CORBIN LOCKS

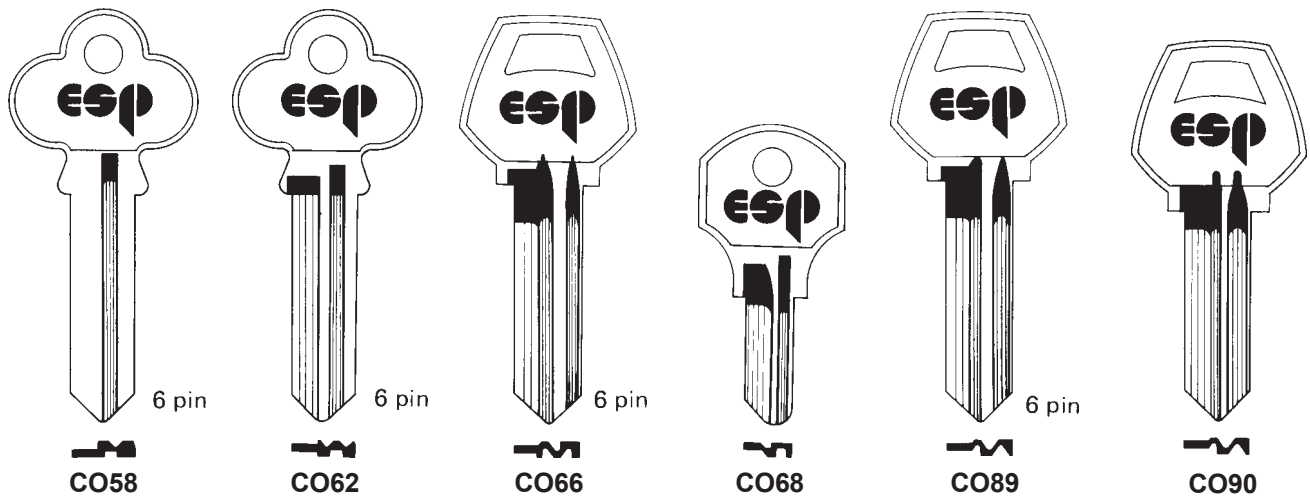

CORBIN LOCKS

ESP CYLINDER KEY BLANKS

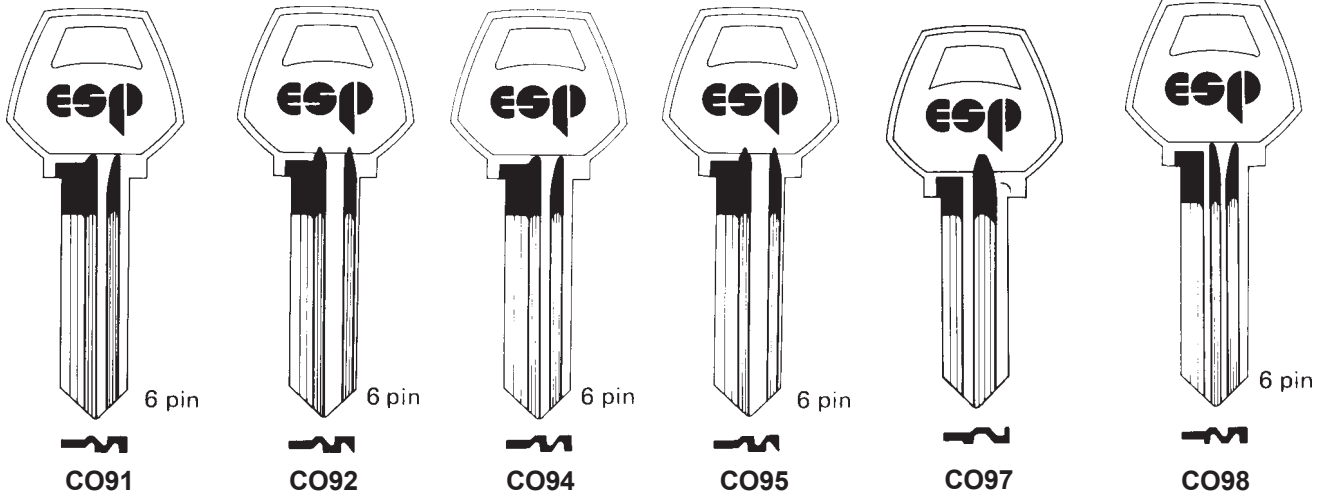

CORBIN LOCKS



CORBIN LOCKS

CORBIN/RUSSWIN

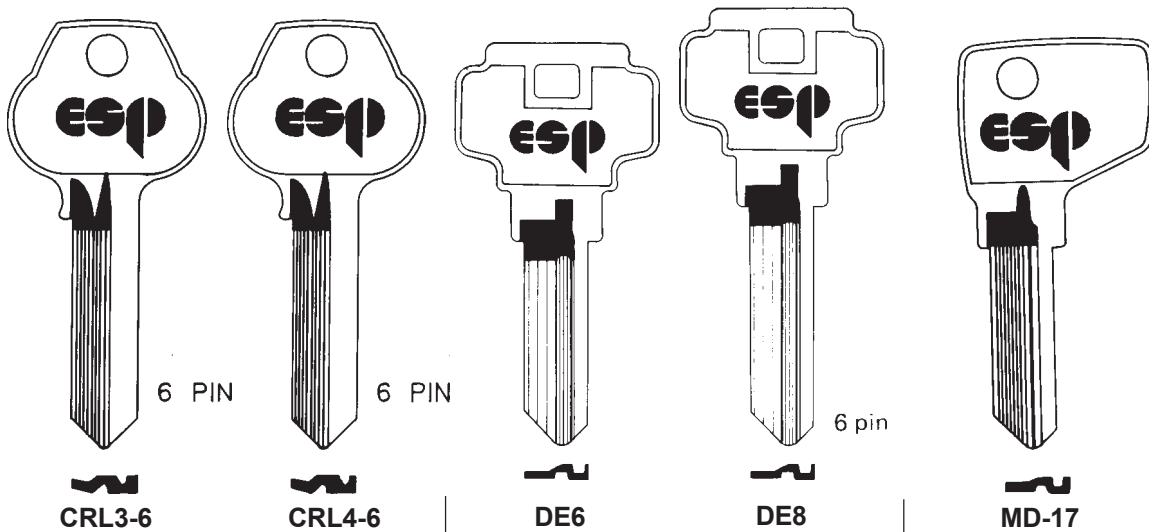

CORBIN/RUSSWIN

DEXTER LOCKS

MASTER/DEXTER

ILCO CYLINDER KEY BLANKS

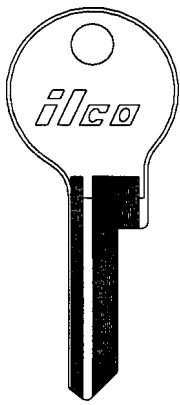

X1000KC

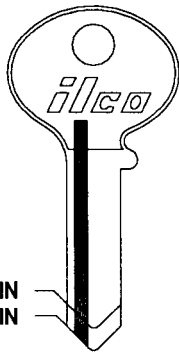

5 PIN
6 PIN

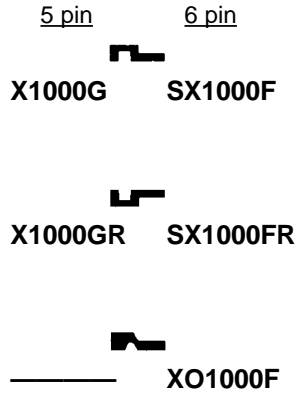

XO1000GR **XO1000FR**

CCL

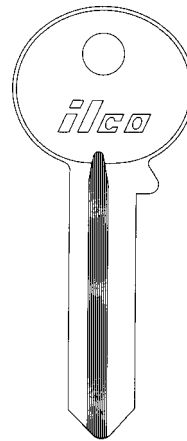

1001DA

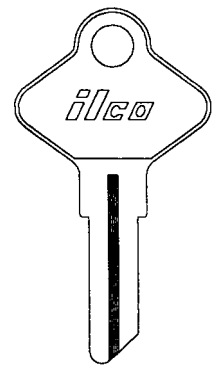

1001JL

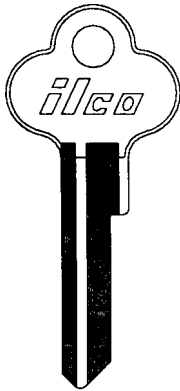

X1001KC

CCL

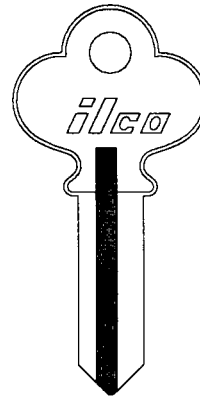

1001C

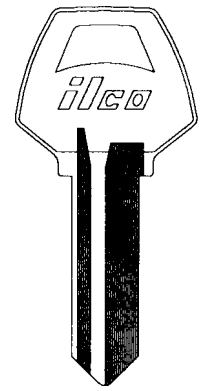

1001GH

(2)

CORBIN (NOW CORBIN/RUSSWIN)

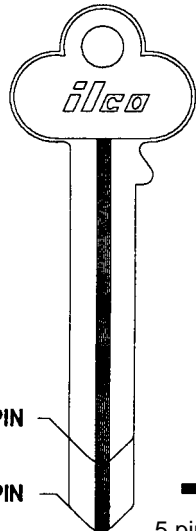

5 PIN

7 PIN

5 pin **1002B**
7 pin **1002**

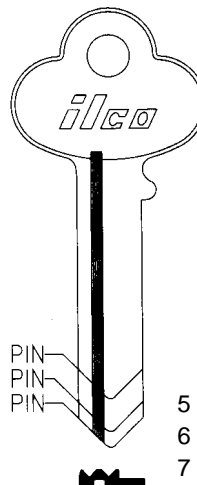

5 PIN
6 PIN
7 PIN

5 pin **1001EB** Master (2)
6 pin **1001EA** Master
7 pin **1001E** Master

CORBIN (NOW CORBIN/RUSSWIN)

1 - Available in Look Alike, see pages 1070-1072.
2 - Available in Taylor Line®, see page 1073.
3 - Available in Bin Pack, see page 1074.

ILCO CYLINDER KEY BLANKS

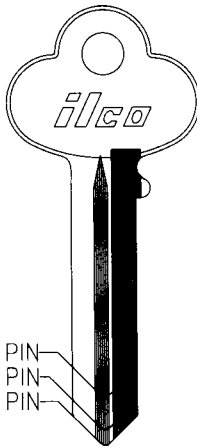

5 pin **R1001EF**

6 pin **R1001ED** **R1001EE**

6 pin **R1001EM** **1001MB**

7 pin **A1001MA** **A1001MB**

7 pin **A1001MF**

5 PIN
6 PIN
7 PIN

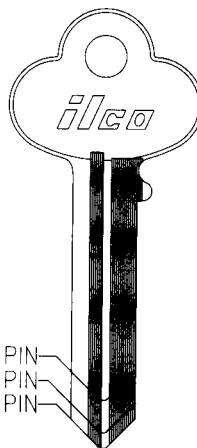

5 pin **1001EN Master**

6 pin **1001EG Master**

7 pin **1001EL Master**

7 pin **B1001EJ**

5 PIN
6 PIN
7 PIN

CORBIN (NOW CORBIN/RUSSWIN)

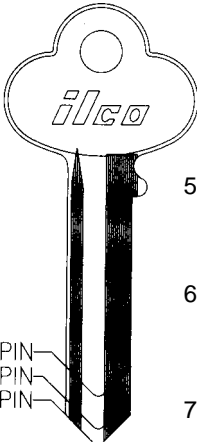

5 pin **R1001EN Master**

6 pin **R1001EG Master**

7 pin **R1001EL Master**

5 PIN
6 PIN
7 PIN

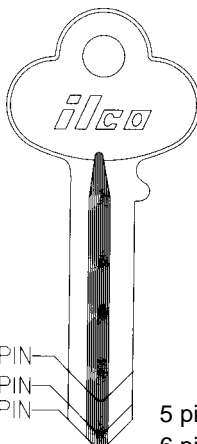

5 pin **1001**

6 pin **1001AB**

7 pin **1001A**

5 PIN
6 PIN
7 PIN

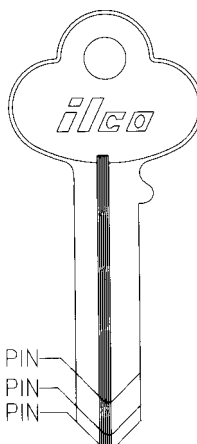

6 pin **1000AB**

7 pin **1000A**

5 PIN
6 PIN
7 PIN

CORBIN (NOW CORBIN/RUSSWIN)

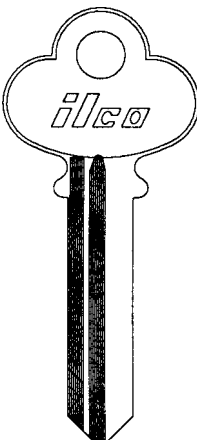

1001GA
7 pin

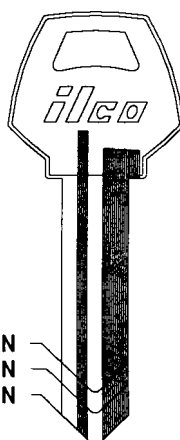

5 pin **1001EH (1, 2)**

6 pin **A1001EH (1, 2)**

7 pin **L1001EH**

5 PIN
6 PIN
7 PIN

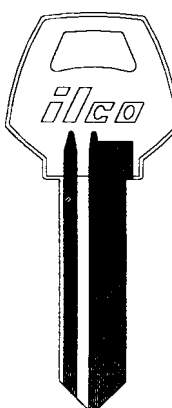

A1001EHR

CORBIN (NOW CORBIN/RUSSWIN)

ILCO CYLINDER KEY BLANKS

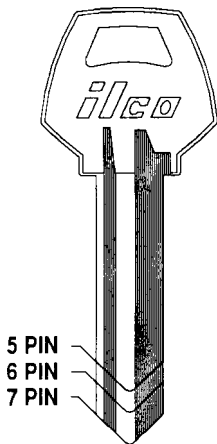
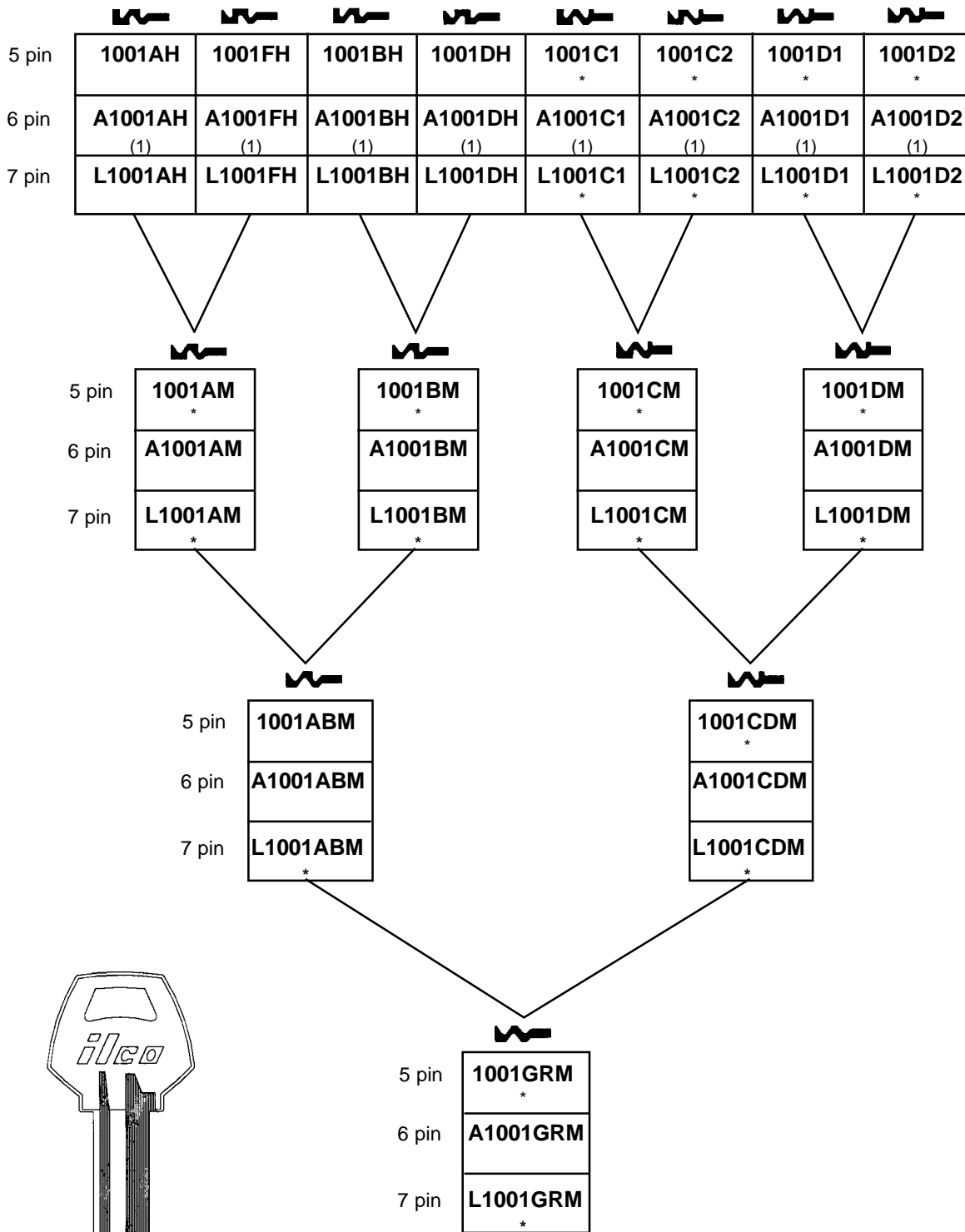

*Available through Special Factory Order only.

CORBIN (NOW CORBIN/RUSSWIN)

1 - Available in Look Alike, see pages 1070-1072.
 2 - Available in Taylor Line®, see page 1073.
 3 - Available in Bin Pack, see page 1074.

ILCO CYLINDER KEY BLANKS

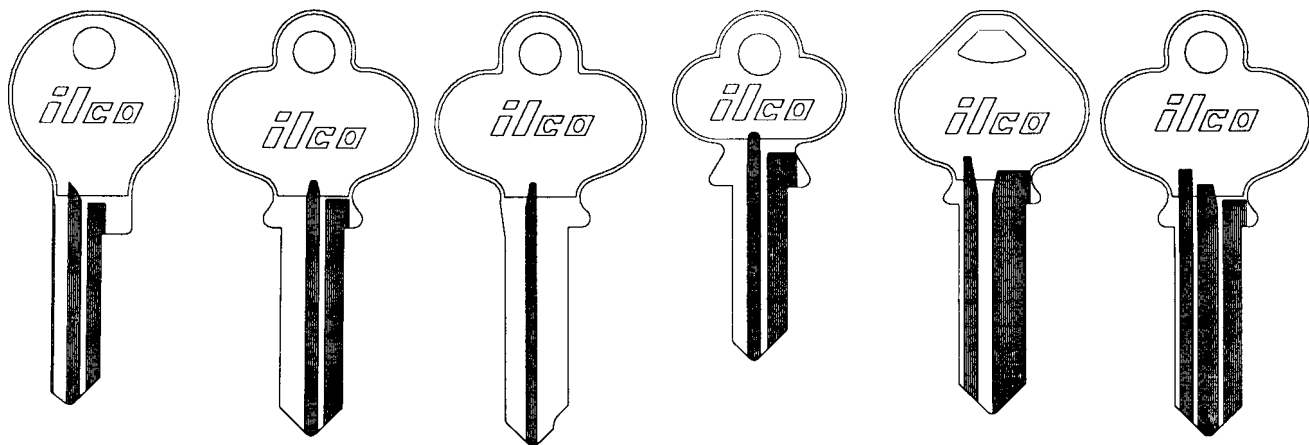

X1000KR

1011



1011-04A

1011B

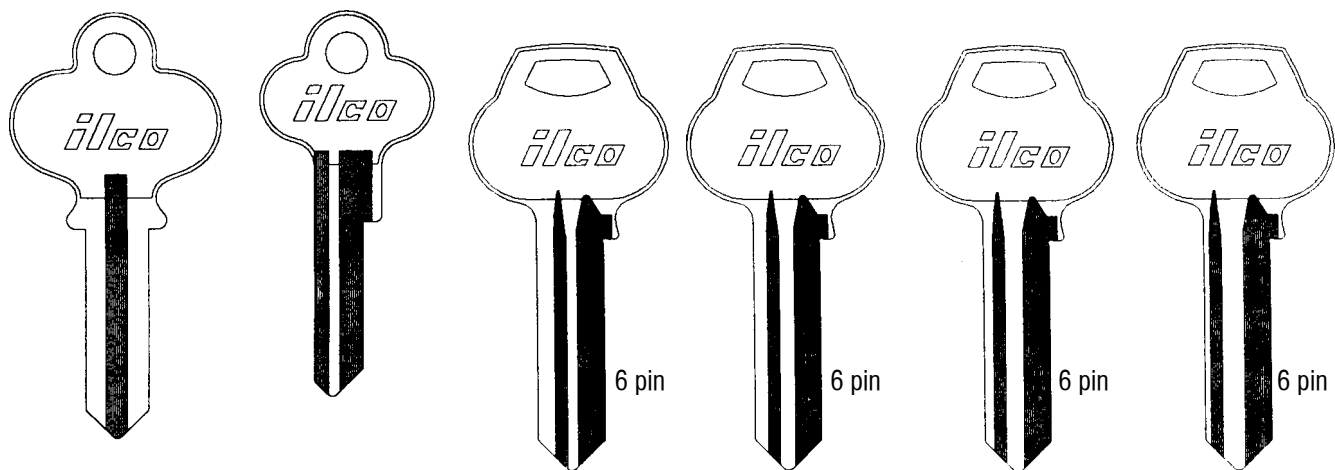

1011GH

1011PZ
MASTER

— CORBIN/RUSSWIN —



1011M

X1001KC

X1011KR



A1011-L1

A1011-L2

A1011-L3

A1011-L4

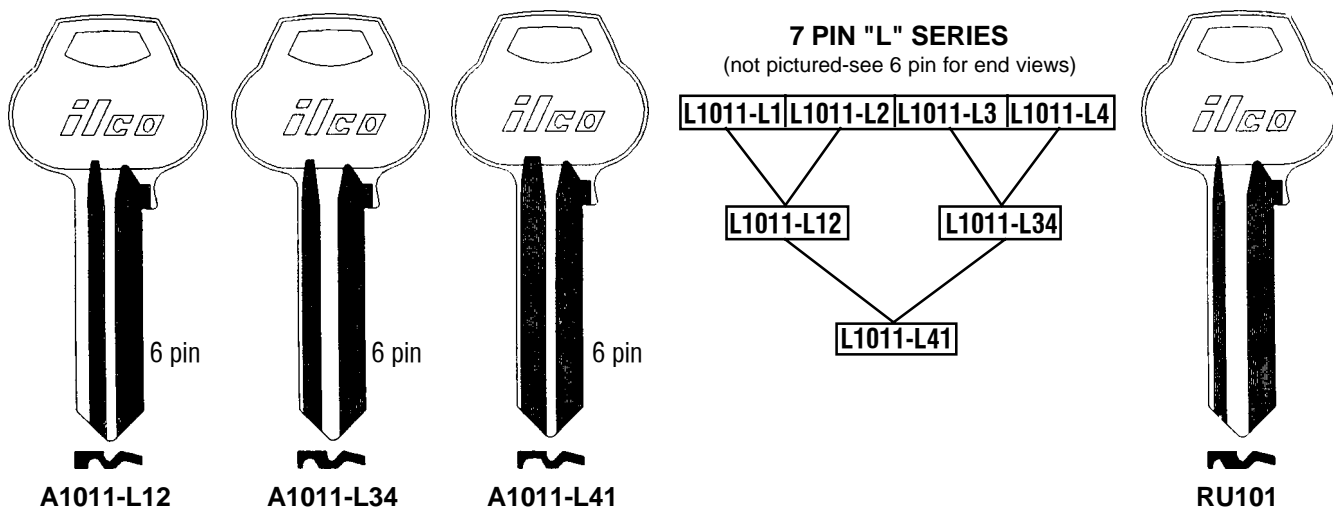
— CORBIN/RUSSWIN —



A1011-L12

A1011-L34

A1011-L41

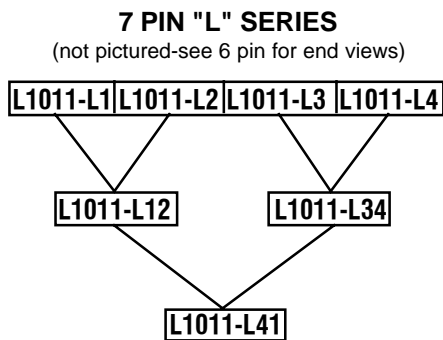

RU101

— CORBIN/RUSSWIN —

ILCO CYLINDER KEY BLANKS

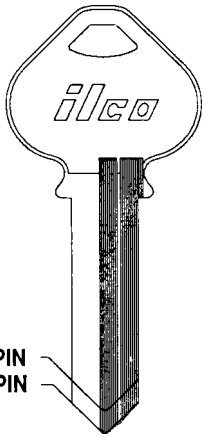

5 PIN
6 PIN

Old Style
1011

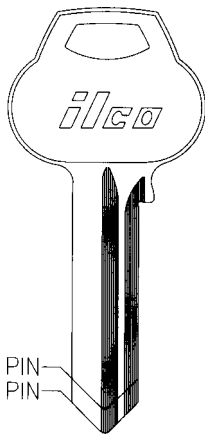

5 PIN
6 PIN

New Style
1012

The 1011 is being replaced by the 1012. 1011 will be sent until stock is depleted and replaced by the 1012.

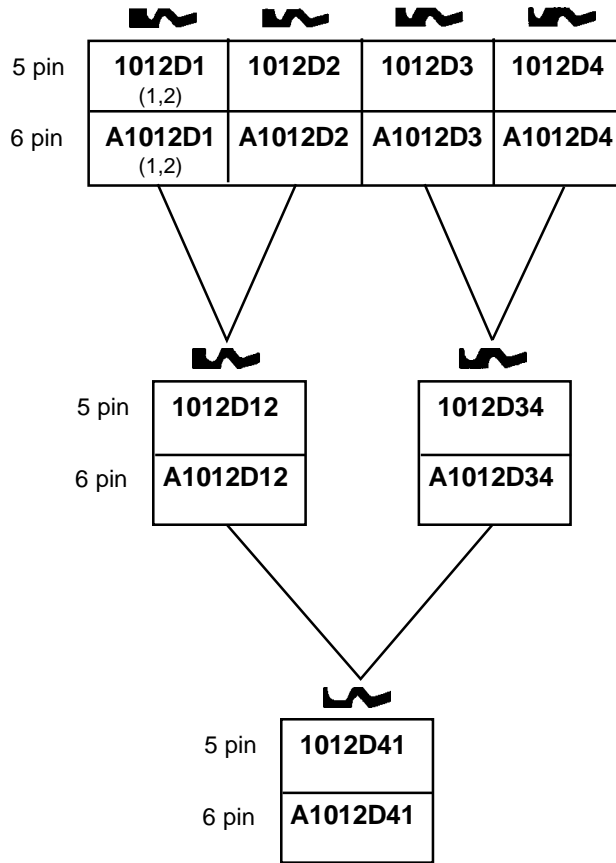

CORBIN/RUSSWIN

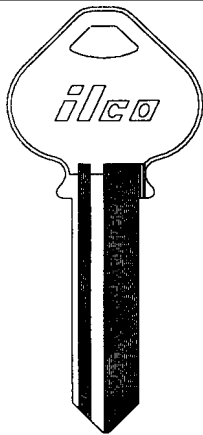

Old Style
A1011

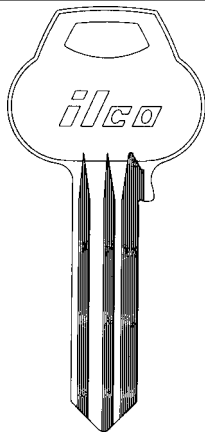

New Style
A1012

The A1011 is being replaced by the A1012. A1011 will be sent until stock is depleted and replaced by the A1012.

A1012-H1 A1012-H6

A1012-H2 A1012-H7









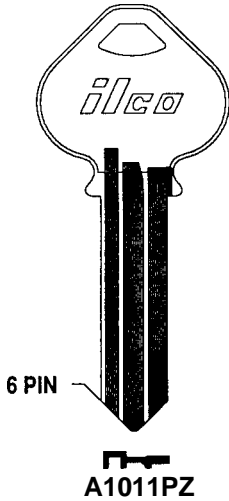





A1012-H3 A1012-H8

A1012-H5

CORBIN/RUSSWIN









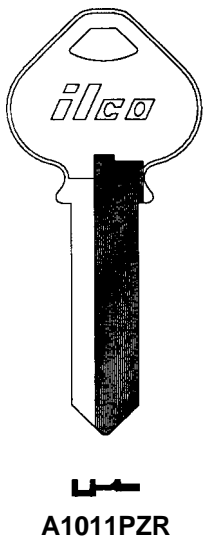





ILCO CYLINDER KEY BLANKS



- | | | |
|---|---|---|
|  A1011-1N |  A1011-8N |  A1011-11N |
|  A1011-4N |  A1011-9N |  A1011-12N |
|  A1011-5N |  A1011-6N |  A1011-2N |
|  A1011-13N |  A1011-3N |  A1011-7N |
|  A1011-10N |  A1011-14N | |

CORBIN/RUSSWIN



- | | | | |
|---|---|---|---|
|  A1011-15N |  A1011-19N |  A1011-23N |  A1011-27N |
|  A1011-16N |  A1011-20N |  A1011-24N |  A1011-28N
(special order) |
|  A1011-17N |  A1011-21N |  A1011-25N | |
|  A1011-18N |  A1011-22N |  A1011-26N | |

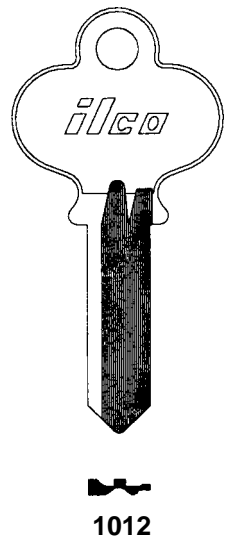

CORBIN/RUSSWIN

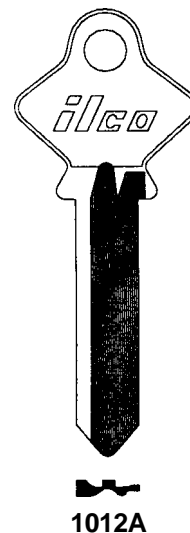
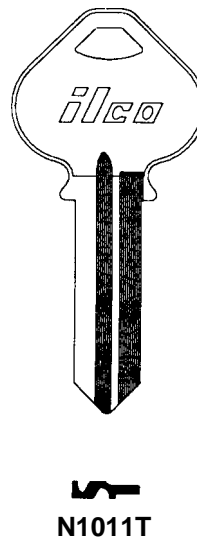
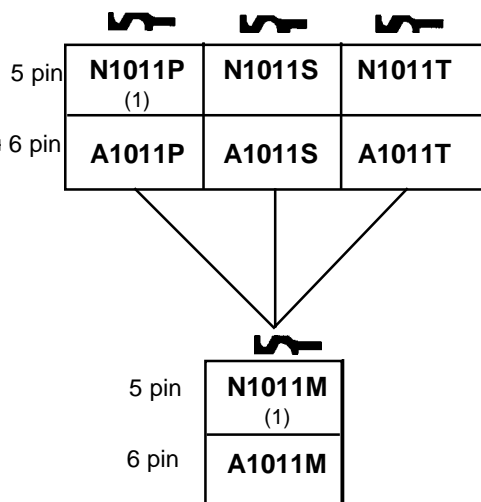
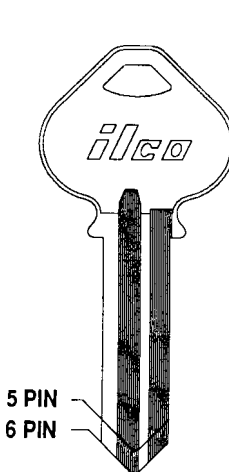

CORBIN/RUSSWIN

ILCO CYLINDER KEY BLANKS

LOOK-A-LIKE KEY BLANKS

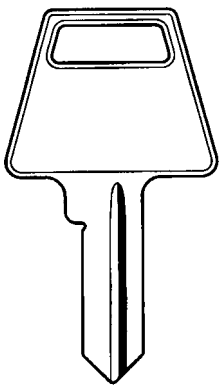

TA-PTKB1
AMERICAN

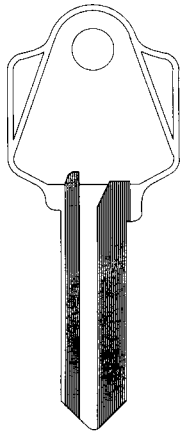

TA-K2A

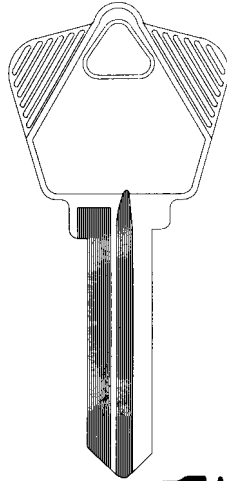

TA-K7

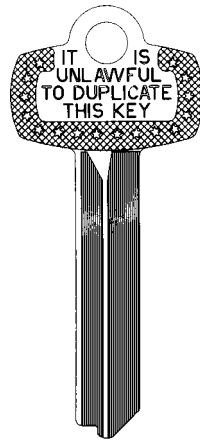

TA-1A1A1 NS



TA-1A1B1 NS



TA-1A1C1 NS



TA-1A1D1 NS



TA-1A1E1 NS



TA-1A1F1 NS



TA-1A1G1 NS



TA-1A1H1 NS



TA-1A1J1 NS



TA-1A1K1 NS



TA-1A1L1 NS



TA-1A1M1 NS



TA-1A1Q1 NS



TA-1A1R1 NS



TA-1A1FM1 NS*

*MASTER-Limited Applications

BEST

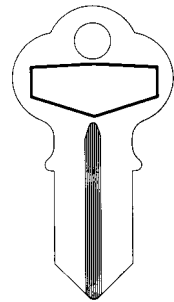

TA-K4

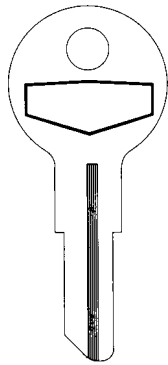

TA-K5

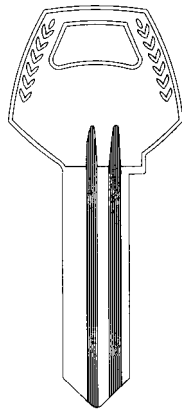

TA-Z1-59A1-6 NS

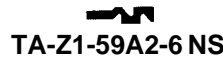

TA-Z1-59A2-6 NS



TA-Z1-59B1-6 NS



TA-Z1-59B2-6 NS



TA-Z1-59C1-6 NS

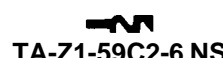

TA-Z1-59C2-6 NS



TA-Z1-59D1-6 NS



TA-Z1-59D2-6 NS

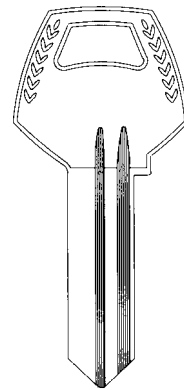

TA-Z1-60-5 NS

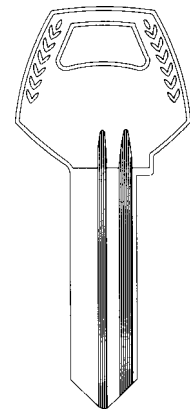

TA-Z1-60-6 NS

CHICAGO

CORBIN (NOW CORBIN/RUSSWIN)

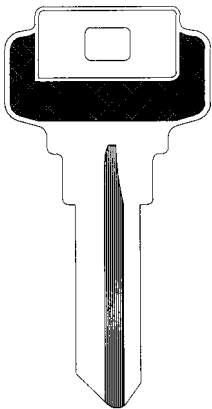

TA-67

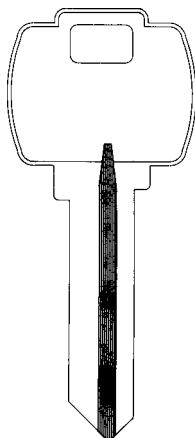

TA-P1577E NS

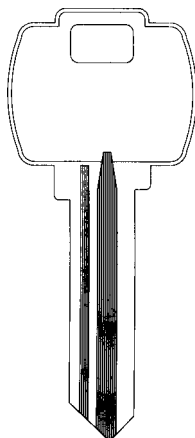

TA-KB1577G NS

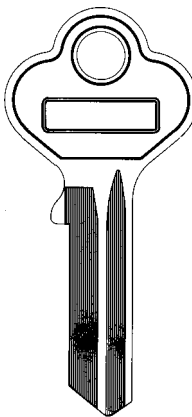

TA-HARLOC

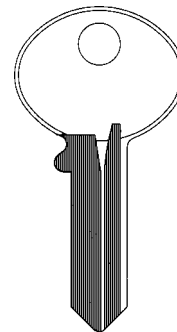

TA-H20

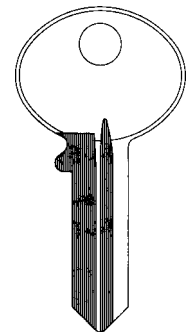

TA-H21

DEXTER/MASTER

FALCON

HARLOC

HUDSON

ILCO CYLINDER KEY BLANKS

LOOK-A-LIKE KEY BLANKS

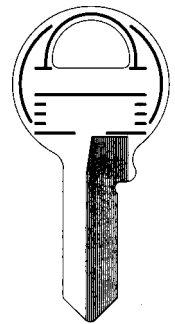
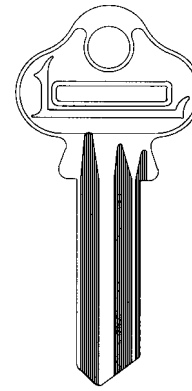
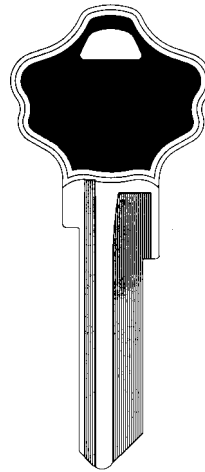
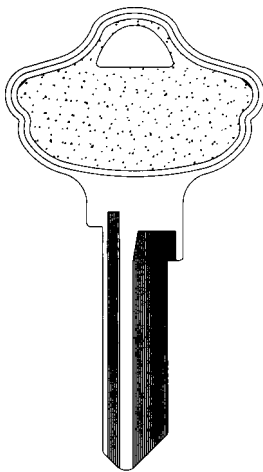
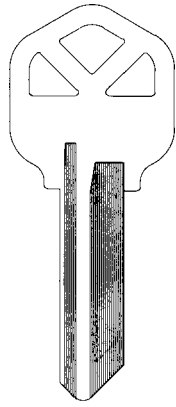
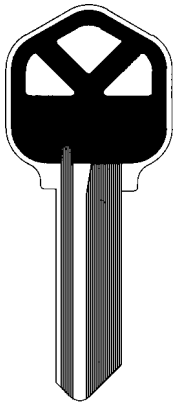

TA-1063KW NP

TA-1063KW BR

TA-07743

TA-08260KW (NS)
TA-83559 (NP)

TA-B308 NP

TA-1K

KWIKSET

LOCKWOOD

MASTER

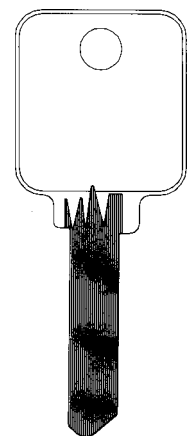
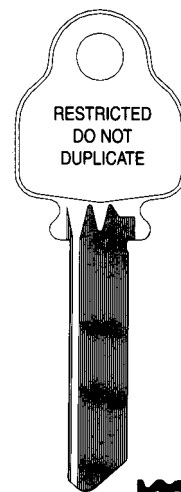
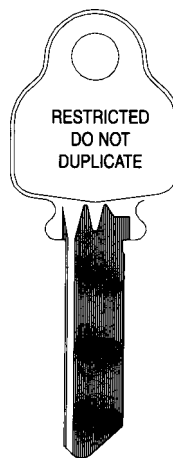
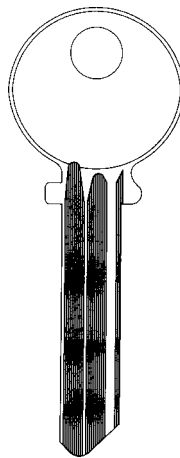
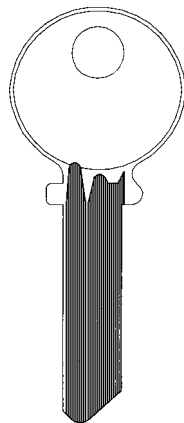
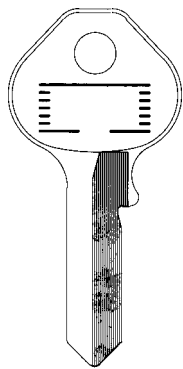

TA-15K

TA-1515 NS

TA-A1515 NS

TA-1517 NS

TA-A1517 NS

TA-1518 NS

MASTER

MEDECO

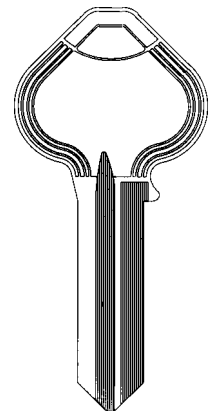
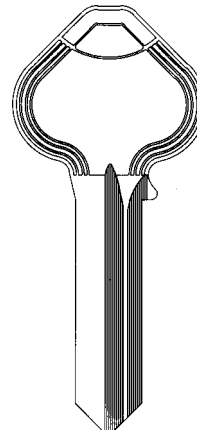
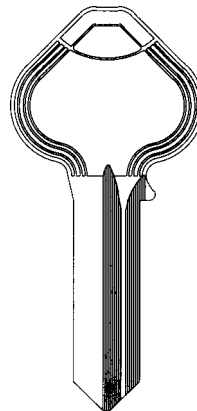
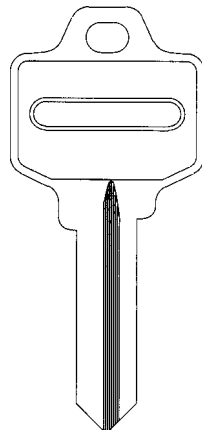
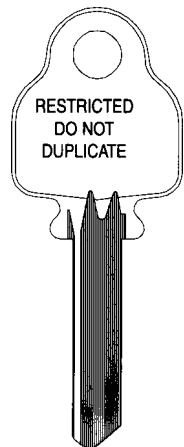
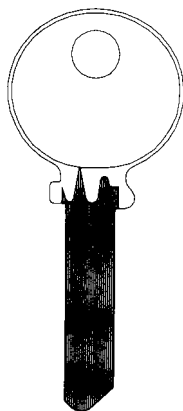

TA-1542 NS

TA-1543 NS

TA-4295

TA-5D1R NS

TA-6D1R NS

TA-5981R NS

MEDECO

NATIONAL

RUSSWIN

Look Alike key blanks are made as close to the original as legally possible. They would meet the industry standards of an original, except they do not carry the original or ILCO logo. They are also normally less expensive than the original equipment key blanks.

JET CYLINDER KEY BLANKS

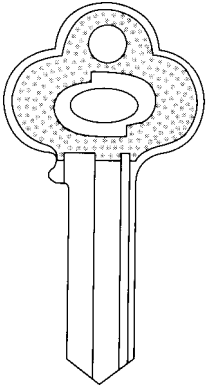

JT-CO1

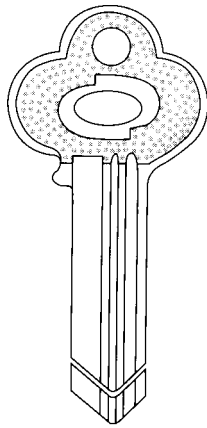

5 pin **JT-CO3**
6 pin **JT-CO4**

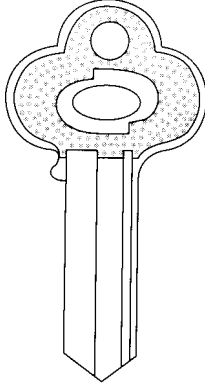

JT-CO5

5 pin
6 pin
7 pin

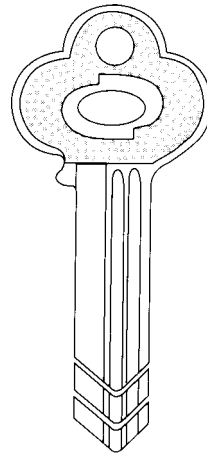

JT-CO7
JT-CO36
JT-CO37

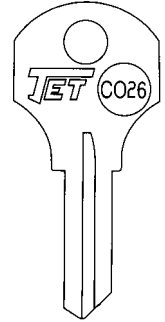

JT-CO26
LARGE

CORBIN

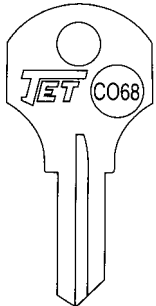

JT-CO68
SMALL

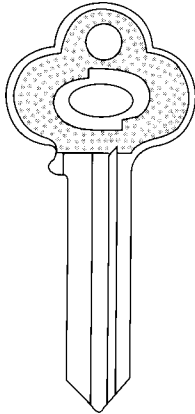

JT-CO62

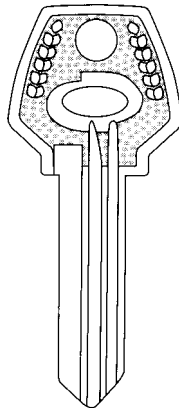

JT-CO51

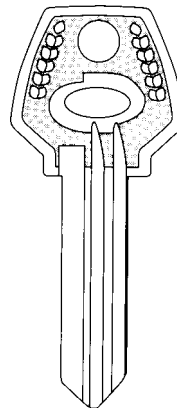

JT-CO52

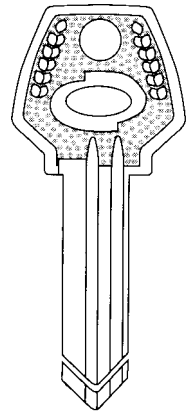

5 pin **JT-CO87**
JT-CO87-250
(250 Blanks in Bulk Pack)
6 pin **JT-CO88**

CORBIN

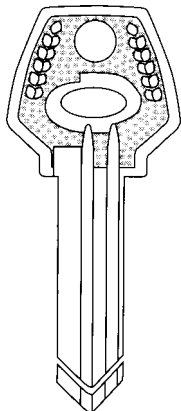

5 pin **JT-CO89**
6 pin **JT-CO90**

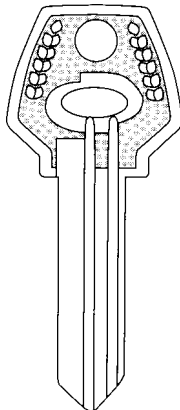

JT-CO91

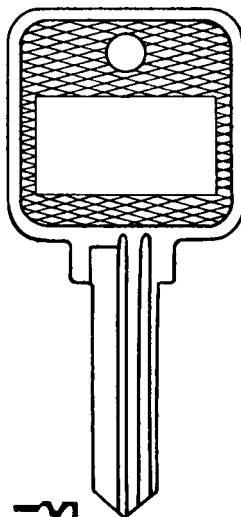

JT-CO91RH
CORBIN

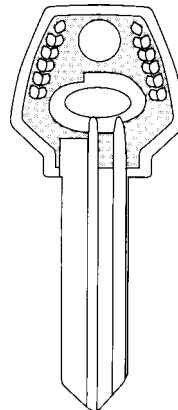

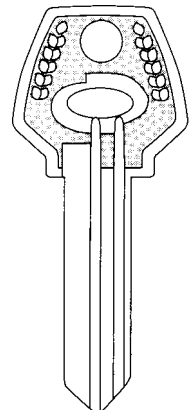

JT-CO92

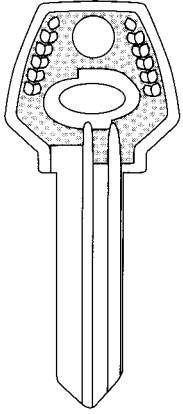

JT-CO94

JET CYLINDER KEY BLANKS



 JT-CO95

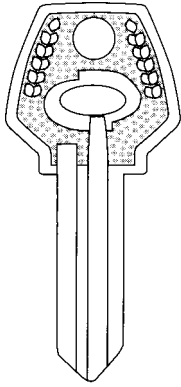

 JT-CO97

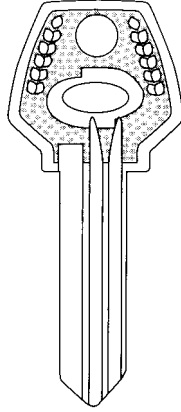

 JT-CO98

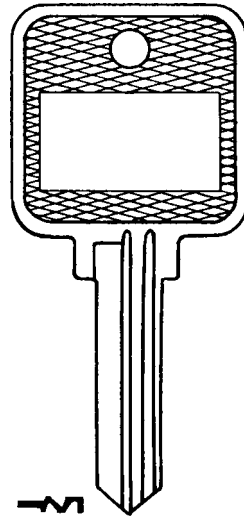

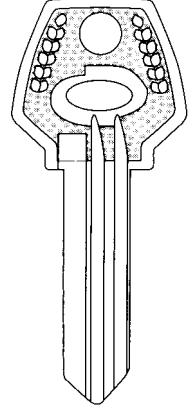

 JT-CO98RH



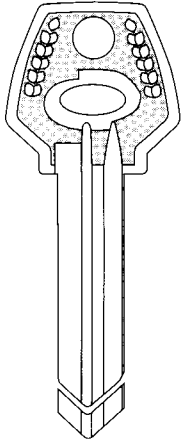

 JT-CO99

CORBIN

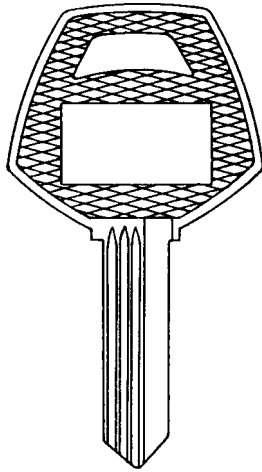

6 pin  JT-O59AD-6
7 pin  JT-O59AD-7



 JT-O57AD-6-CH

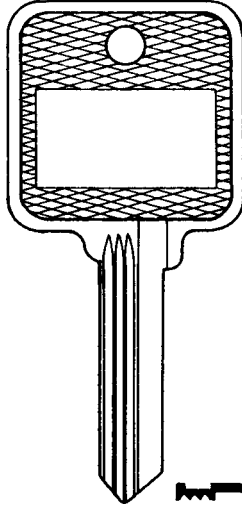

 JT-O57AD-6-RH

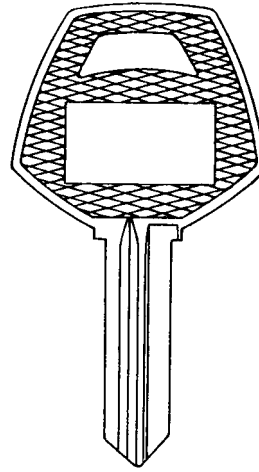

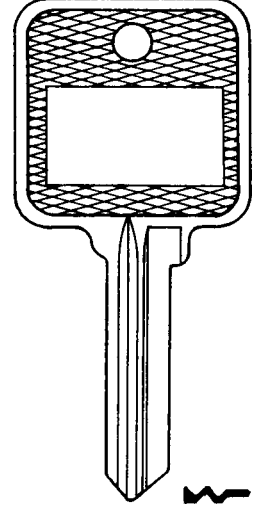

 JT-O59AD-6-CH



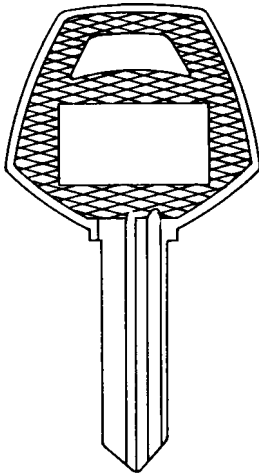

 JT-O59AD-6-RH

CORBIN

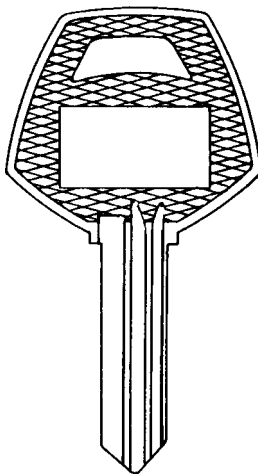

 JT-O59A1-6-CH



 JT-O59C1-6-CH

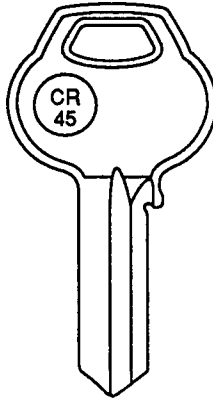

 JT-CR45

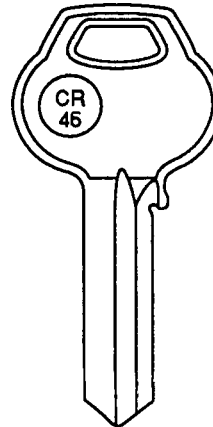

 JT-CR46
CORBIN/RUSSWIN

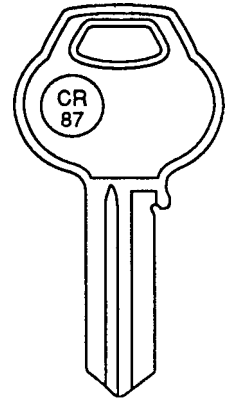

 JT-CR87

CORBIN

CORBIN/RUSSWIN

JET CYLINDER KEY BLANKS

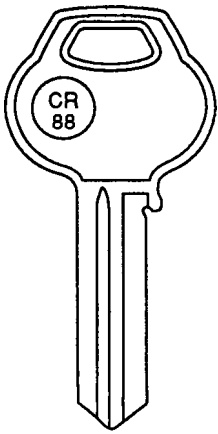

 JT-CR88

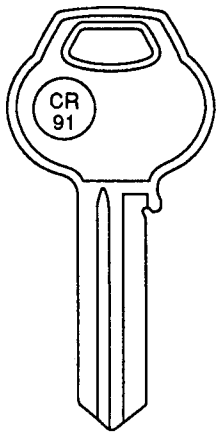

 JT-CR91

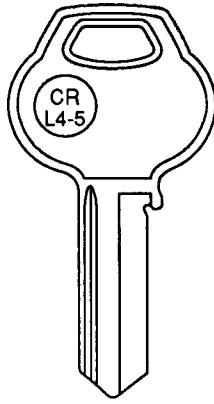

 JT-CR-L4-5

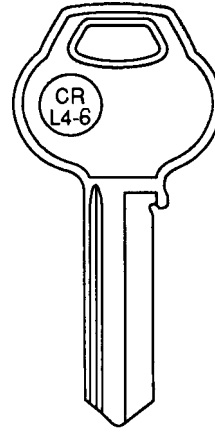

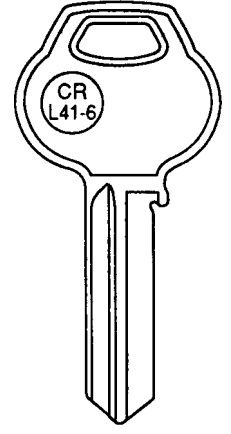

 JT-CR-L4-6

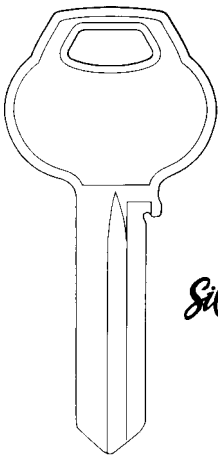

 JT-CR-L41-6

CORBIN/RUSSWIN



 JS-D2-6 NS



 JS-D1-6 NS

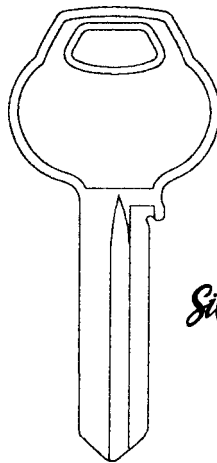

 JS-D3-6 NS

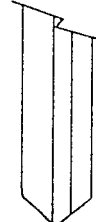

 JS-D4-6 NS

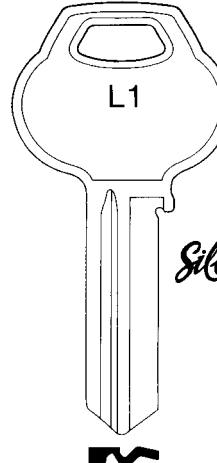

 JS-L1-6 NS

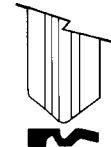

 JS-L2-6 NS

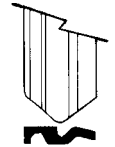

 JS-L3-6 NS

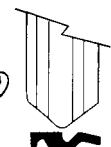

 JS-L4-6 NS

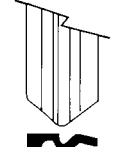

 JS-L12-6 NS

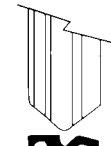

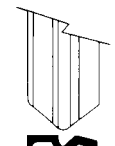

 JS-L34-6 NS



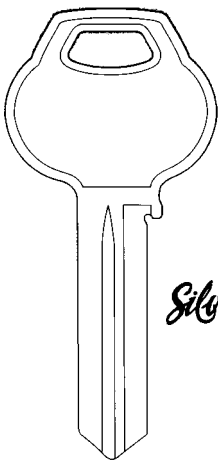

 JS-L41-6 NS

CORBIN/RUSSWIN

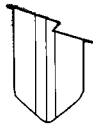

 JS-59A1-6 NS



 JS-59A2-6 NS

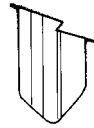

 JS-59B1-6 NS

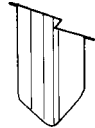

 JS-59B2-6 NS

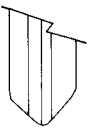

 JS-59C1-6 NS

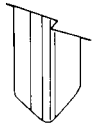

 JS-59C2-6 NS

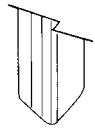

 JS-59D1-6 NS

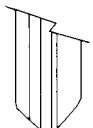

 JS-59D2-6 NS

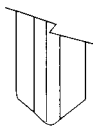



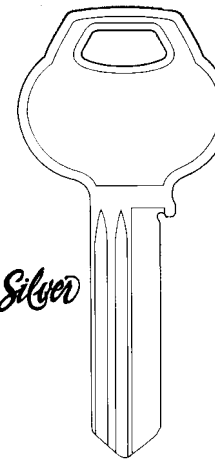



 JS-60-6 NS



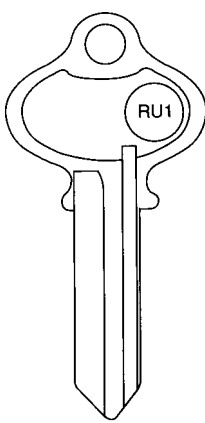
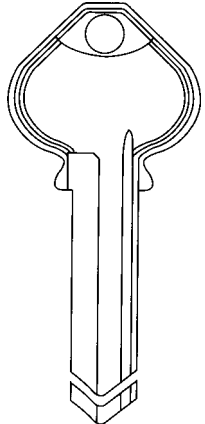
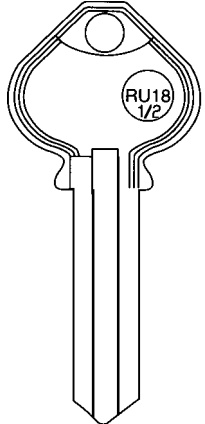
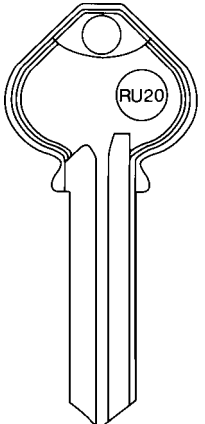
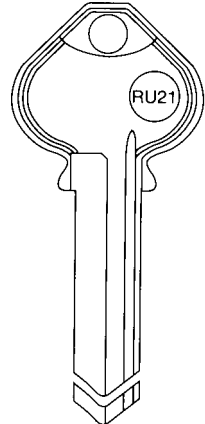
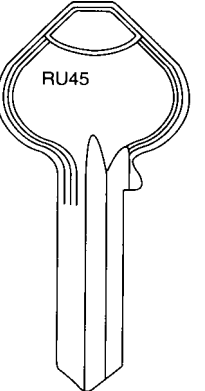







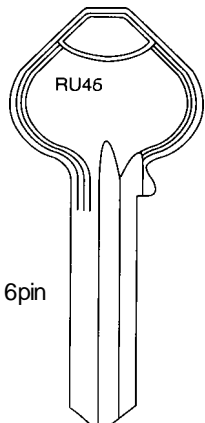
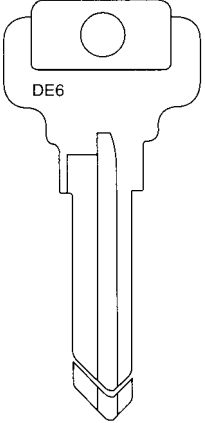
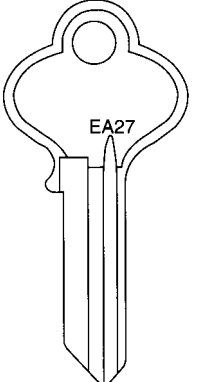
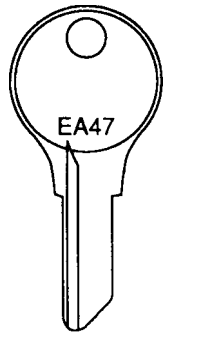
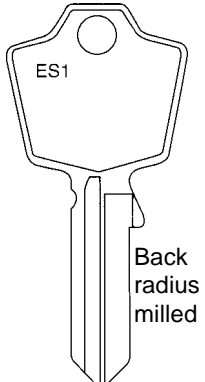



 JS-77-6 NS

CORBIN/RUSSWIN

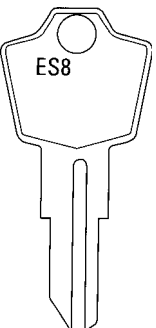
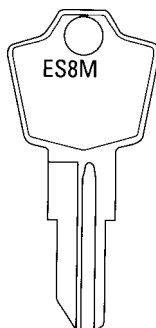
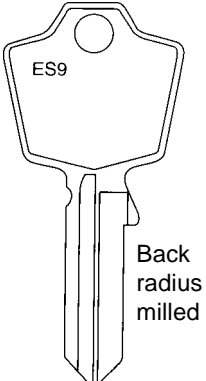
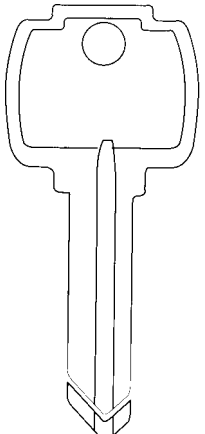
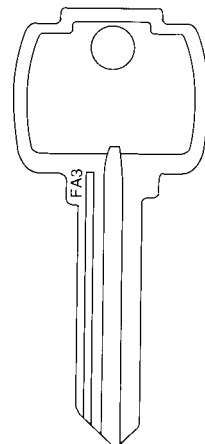
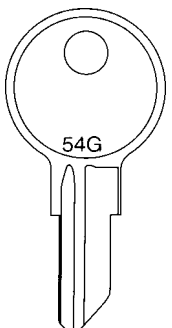
JET CYLINDER KEY BLANKS

 <p style="text-align: center;">RU1</p>		 <p style="text-align: center;">RU18 1/2</p>	 <p style="text-align: center;">RU20</p>	 <p style="text-align: center;">RU21</p>	 <p style="text-align: center;">RU45</p>
 JT-RU1	 5 pin JT-RU4 6 pin JT-RU16	 JT-RU18-1/2	 JT-RU20	 5 pin JT-RU21 6 pin JT-RU22	 JT-RU45 1 JT-RU45-250 (250 Blanks in Bulk Pack)
CORBIN/RUSSWIN					

 <p style="text-align: center;">RU46</p> <p style="text-align: center;">6pin</p>	 <p style="text-align: center;">DE6</p>	 <p style="text-align: center;">EA27</p>	 <p style="text-align: center;">EA47</p>	 <p style="text-align: center;">ES1</p> <p style="text-align: right;">Back radius milled</p>
 JT-RU46 1 JT-RU46-250 (250 Blanks in Bulk Pack)	 5 pin JT-DE6 1 JT-DE6-250 (250 Blanks in Bulk Pack)	 JT-EA27	 JT-EA47	 JT-ES1
CORBIN/RUSSWIN	DEXTER	EAGLE		ESP

 <p style="text-align: center;">ES8</p>	 <p style="text-align: center;">ES8M</p>	 <p style="text-align: center;">ES9</p> <p style="text-align: right;">Back radius milled</p>		 <p style="text-align: center;">FA3</p>	 <p style="text-align: center;">54G</p>
 JT-ES8	 JT-ES8M ESP	 JT-ES9	 5 pin JT-FA1 6 pin JT-FA2	 JT-FA3	 JT-54G FORT
			FALCON		

1 - Available in Uni Bow Head, see page 1090

JET CYLINDER KEY BLANKS

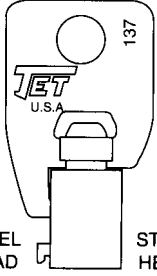
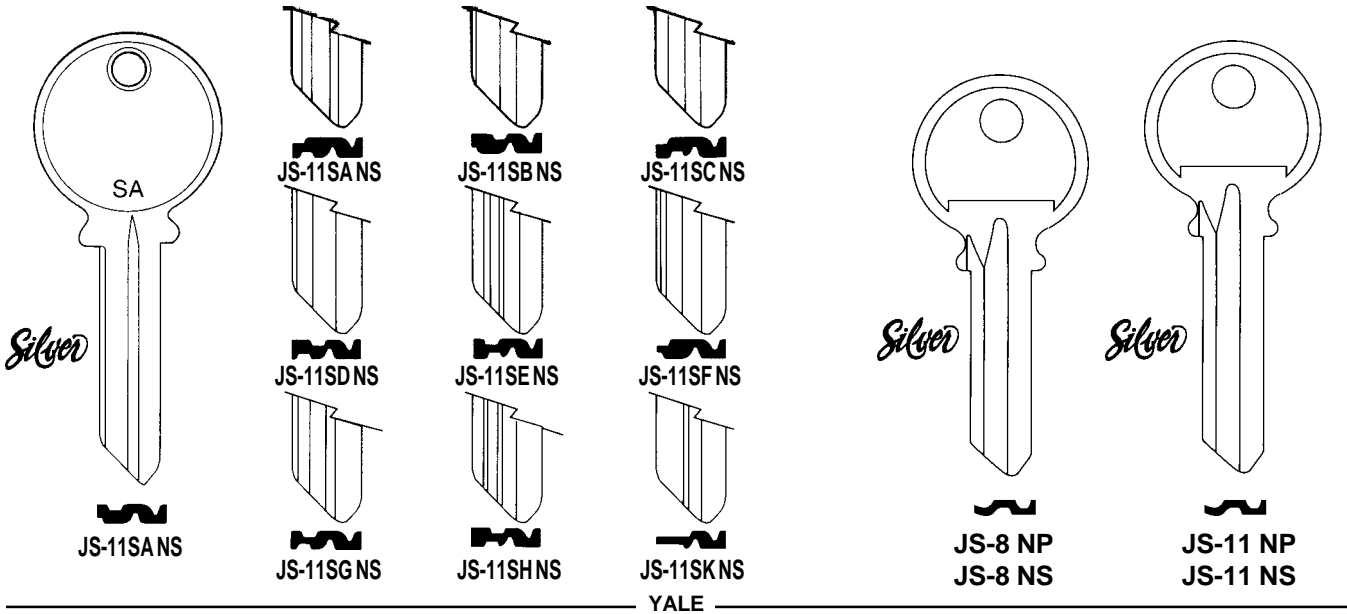

STEEL HEAD STEEL HEAD
 STEEL O.D. .377 BRASS
 TUBE I.D. .312 TUBE



JT-137S JT-137B
 TUBULAR KEY

"ONLY THE PROFESSIONAL KNOWS FOR SURE..."

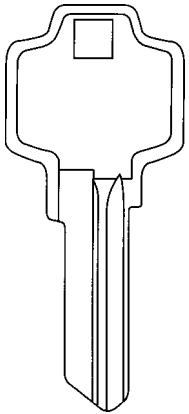

PLAIN (BOTH SIDES)

MFG.	MFG #	JET #	
ARROW	K2	JT-AR1-UN	
DEXTER	67	JT-DE6-UN	
KWIKSET	1063KW	JT-KW1-UN	
MASTER	1K, 77K	JT-M1-UN	
RUSSWIN	6D1R	JT-RU46-UN	
SCHLAGE	100-C	JT-SC1-UN	
SCHLAGE	101-C	JT-SC4-UN	
SCHLAGE	100-E	JT-SC8-UN	
SCHLAGE	101-E	JT-SC9-UN	
SEGAL	K9	JT-SE1-UN	
WEISER	P1555	JT-WR3-UN	
YALE	8	JT-Y1-UN	