

# DOOR & CYLINDER GUARDS

## LATCH PROTECTORS

The INTERLOCK for inswinging doors

<u>Stock No.</u>	<u>Size</u>	<u>Finish</u>
DJ-ILP206 SL	6"	Silver Coated
DJ-ILP206 DU	6"	Duro Coated
DJ-ILP206 BP	6"	Brass Plated
DJ-ILP212 SL	12"	Silver Coated
DJ-ILP212 DU	12"	Duro Coated
DJ-ILP212 BP	12"	Brass Plated

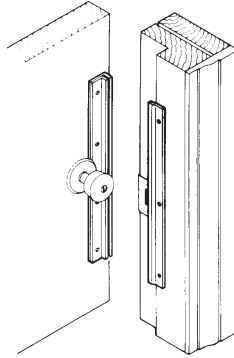

# DON-JO

- 6" version for use with key-in-knob and deadbolt locks.
- 12" version for use with mortise locks, Simplex 1000 series, Alarm Lock DL-2500, DL-2700 & DL-3000, Card Access Systems, etc.
- 14 ga. (.075) Steel.

For Aluminum Entrance Doors

<u>Stock No.</u>	<u>Finish</u>
DJ-LP307 DU	Duro Coated
DJ-LP307 SL	Silver Coated

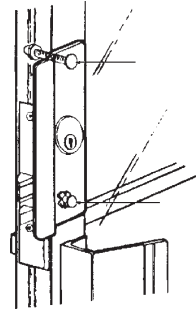

- Reversible.
- Fits over cylinder, lock removal NOT required.
- Hand carriage bolt and rivet supplied.
- No specific tools required.
- 3/8" offset.
- 2-5/8" x 7" x 1/8".
- 12 ga. (.104) Steel.

For Aluminum Entrance Doors - solves pull handle interference

<u>Stock No.</u>	<u>Finish</u>
DJ-GLP307 DU	Duro Coated

Specify Hand: LHR or RHR  
(LHR shown in picture)

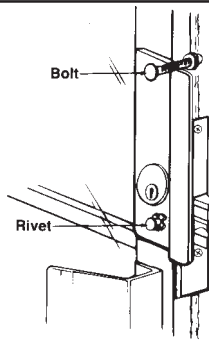

- **Handed: LHR or RHR.**
- Fits over cylinder, lock removal NOT required.
- Hand carriage bolt and rivet supplied.
- No specific tools required.
- 3/8" offset.
- 2-5/8" x 7" x 1/8".
- 12 ga. (.104) Steel.
- Center of cylinder hole is 2-1/2" from end of plate.

For Center Hung Outswinging Aluminum Doors

<u>Stock No.</u>	<u>Finish</u>	<u>Offset</u>
DJ-OLP2650DU	Duro Coated	1-1/8"
DJ-OLP2650SL	Silver Coated	1-1/8"
DJ-OLP2651DU	Duro Coated	1-3/8"
DJ-OLP2651SL	Silver Coated	1-3/8"

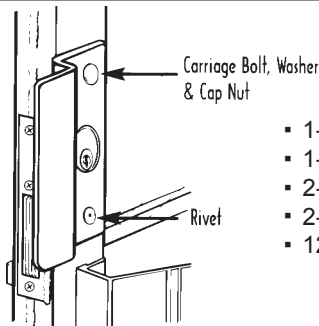

- 1-1/8" offset (OLP-2650).
- 1-3/8" offset (OLP-2651).
- 2-5/8" x 6-1/2" x 1/8" (OLP-2650).
- 2-5/8" x 6-1/2" x 3/8" (OLP-2651).
- 12 ga. (.104) Steel.

For Outswinging Doors - completely covers the strike plate

<u>Stock No.</u>	<u>Finish</u>
DJ-MLP111 630	Stainless Steel
DJ-MLP211 BP	Brass Plated
DJ-MLP211 DU	Duro Coated
DJ-MLP211 SL	Silver Coated

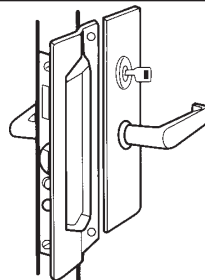

- Furnished with carriage bolts, washers & acorn nut for safety and strength.
- 3" x 11".
- 12 ga. (.104) Steel

©ZIPF LOCK COMPANY

# DOOR & CYLINDER GUARDS

## LATCH PROTECTORS

# DON-JO

For Outswinging Doors - completely covers the strike plate

<u>Stock No.</u>	<u>Finish</u>
DJ-LP111 630	Stainless Steel
DJ-LP211 BP	Brass Plated
*DJ-9211 BP	Brass Plated
DJ-LP211 DU	Duro Coated
*DJ-9211 DU	Duro Coated
DJ-LP211 PC	Prime Coated
*DJ-9211 PC	Prime Coated
DJ-LP211 SL	Silver Coated

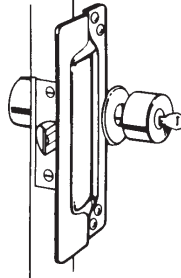

- Furnished with carriage bolts, washers & acorn cap nuts.
- 3" x 11"
- Fits 2-3/4" and 2-3/8" backsets.
- 12 ga. (.104) Steel.

**\*SAVE MONEY: DJ-9211 are poly-bagged and sold in multiples of 10.**

### Pin Latch Protector for Outswinging Doors

<u>Stock No.</u>	<u>Finish</u>
DJ-PLP111 630	Stainless Steel
DJ-PLP211 BP	Brass Plated
DJ-PLP211 DU	Duro Coated
DJ-PLP211 SL	Silver Coated
DJ-PLP211 626	Satin Chrome



- Solid steel pin prevents spreading of door from frame.
- Pin is welded on back leaving no visible point of attack from outside.
- Extra Large cut out accepts **up to 3-1/2" rose.**
- Fits 2-3/4" and 2-3/8" backset.
- 3" x 11".
- 12 ga. (.104) Steel

### Pin Latch Protector for Outswinging Doors

<u>Stock No.</u>	<u>Finish</u>
DJ-PMLP111 630	Stainless Steel
DJ-PMLP211 BP	Brass Plated
DJ-PMLP211 DU	Duro Coated
DJ-PMLP211 SL	Silver Coated

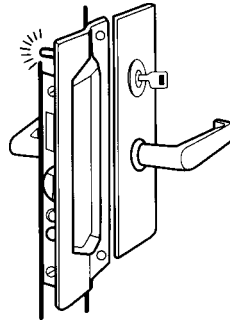

- Solid steel pin prevents spreading of door from frame.
- Pin is welded on back leaving no visible point of attack from outside.
- Fits 2-3/4" and 2-3/8" backset.
- 3" x 11".
- 12 ga. (.104) Steel

### For Outswinging Doors

<u>Stock No.</u>	<u>Finish</u>
DJ-LP107 630	Stainless Steel
DJ-LP207 BP	Brass Plated
DJ-LP207 SL	Silver Coated
DJ-LP207 DU	Duro Coated



- Furnished with carriage bolts, washers & acorn cap nuts.
- 2-3/4" x 7"
- 12 ga. (.104) Steel

### Commercial Type For Outswinging Doors

<u>Stock No.</u>	<u>Finish</u>	<u>Dimensions</u>
DJ-CLP106 630	Stainless Steel	2-1/8" x 6"
DJ-CLP110 630	Stainless Steel	2-1/8" x 10"

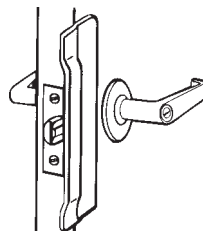

- 6" for key-in-knobs.
- 10" for mortise locks.
- Architectural design.
- Concealed welded studs with fasteners.
- 12 ga. (.104) Steel

©ZIPF LOCK COMPANY

# DOOR & CYLINDER GUARDS

## LATCH PROTECTORS

# DON-JO

### Narrow Commercial Type For Outswinging Doors

<u>Stock No.</u>	<u>Size</u>	<u>Finish</u>
DJ-NLP106 630	6"	Stainless Steel
DJ-NLP206 DU	6"	Duro Coated
DJ-NLP206 PC	6"	Prime Coated
DJ-NLP206 SL	6"	Silver Coated
DJ-NLP110 630	10"	Stainless Steel
DJ-NLP210 DU	10"	Duro Coated
DJ-NLP210 PC	10"	Prime Coated
DJ-NLP210 SL	10"	Silver Coated



- 6" for key-in-knob.
- 10" for mortise locks.
- Narrow type for outswinging doors.
- NLP106: 1-1/2" x 6"
- NLP110: 1-1/2" x 10"
- NLP206: 1-1/2" x 6"
- NLP210: 1-1/2" x 10"
- 12 ga. (.104) Steel.

### For Key-In-Lever with up to 3-3/4" escutcheon

<u>Stock No.</u>	<u>Finish</u>
DJ-BLP107 630	Stainless Steel
DJ-BLP207 BP	Steel Brass Plated
DJ-BLP207 DU	Duro Coated
DJ-BLP207 SL	Silver Coated

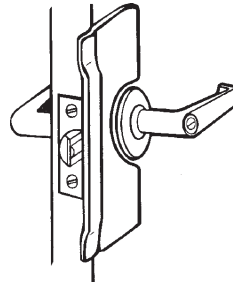

- Works with up to 3-3/4" rose.
- Fits most heavy duty key-in-lever locks.
- Concealed welded studs and fasteners.
- 3-1/4" x 7".
- 12 ga. (.104) Steel.

### For Electronic Locks

<u>Stock No.</u>	<u>Finish</u>
DJ-KLP110 LH 630	Stainless Steel
DJ-KLP110 RH 630	Stainless Steel

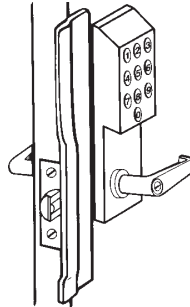

- Works with ILCO 1000, 4000 locks.
- Alarm Lock Trilogy locks.
- Mas-Hamilton Power Levers.
- Schlage Cobra locks.
- 1-1/2" x 10".
- 12 ga. (.104) Steel.

### Angle Type for Outswinging Doors

<u>Stock No.</u>	<u>Size</u>	<u>Finish</u>
DJ-ALP206 BC	6"	Brass Coated
DJ-ALP206 DU	6"	Duro Coated
DJ-ALP206 SL	6"	Silver Coated
DJ-ALP210 BC	10"	Brass Coated
DJ-ALP210 DU	10"	Duro Coated
DJ-ALP210 SL	10"	Silver Coated

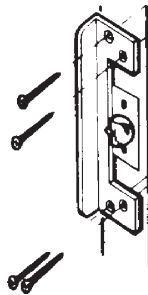

- 6" for key-in-knob.
- 10" for mortise locks.
- 1-1/2" sheet metal screws for wood or metal.
- 10 ga. (.134) Steel

### For use with Electric Strikes

<u>Stock No.</u>	<u>Finish</u>
DJ-ELP208 DU	Duro Coated
DJ-ELP208 SL	Silver Coated
DJ-ELP208P DU*	Duro Coated
DJ-ELP208P SL*	Silver Coated

\*Without cylinder hole.

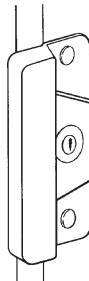

- Available with or without cylinder hole.
- Designed to fit most electric strikes.
- Completely encases the keeper for maximum protection.
- 3-1/2" x 8".
- 12 ga. (.104) Steel.

©ZIPF LOCK COMPANY

# DOOR & CYLINDER GUARDS

## LATCH PROTECTORS

# DON-JO

Fits Folger Adams Electric Strike - for outswinging doors.

**Stock No.**

DJ-FLP211 SL

**Finish**

Silver Coated

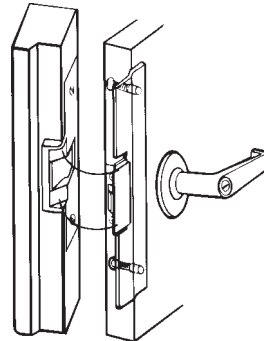

- Works with Folger Adams 310 & 710.
- 1-3/4" x 11-1/4".
- 12 ga. (.104) Steel.

### Short Type for Outswinging Doors

**Stock No.**

DJ-SLP206 BP

**Finish**

Brass Plated

DJ-SLP206 SL

Silver Coated

DJ-SLP206 DU

Duro Coated

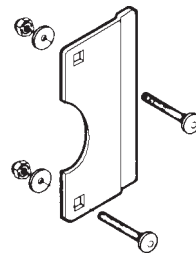

- Furnished with carriage bolts, washers & acorn cap nuts for safety & strength.
- May be used on hollow metal door/frame using ANSI strike.
- Works with up to 3-3/4" rose.
- 2-1/2" x 6"
- 12 ga. (.104) Steel

### Slimline for Outswinging Doors

**Stock No.**

DJ-LP2878 DU

**Finish**

Duro Coated

DJ-LP2878 PC

Prime Coated

DJ-LP2878 SL

Silver Coated



- Fasteners Included.
- Sleek Appearance.
- 1-1/2" x 8-7/8" x 5/16".
- 5/16" thick (.3125) Steel.

### Fits Adams Rite Latch Lock for outswinging doors

**Stock No.**

DJ-LP312 DU

**Finish**

Duro Coated

DJ-LP312 SL

Silver Plated

DJ-LP312P DU\*

Duro Coated

DJ-LP312P SL\*

Silver Coated

\* No Center Hole

DJ-LP312P supplied without 1-7/16" hole. Allows installer to drill hole for custom applications.

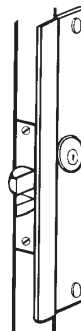

- Reversible.
- 1/4" Offset.
- 1-7/16" Hole (also available w/o hole).
- 1-1/8" Backset.
- 2-5/8" X 12" X 1/8".
- 12 ga. (.104) Steel.

## Your warehouse around the corner!!!

# DOOR & CYLINDER GUARDS

## ALUMINUM DOOR SECURITY



### STYLE GUARD—K-9/K-21

Made of 12 gauge steel, Style Guard reinforces or repairs aluminum-style doors. 8" long. KD-K-9 for standard 4" jamba and KD-K-21 for 4-1/2" jamba. Designed with a "knock-out" to accommodate either the W&F or the Adams Rite bolt. Baked on enamel-type finish matches nicely for a professional looking job.

Stock No.	Length	Finish
KD-K-9A 626	4"	Aluminum Finish
KD-K-9B 613	4"	Duronotic Finish
KD-K-21A 626	4-1/2"	Aluminum Finish
KD-K-21B 613	4-1/2"	Duronotic Finish

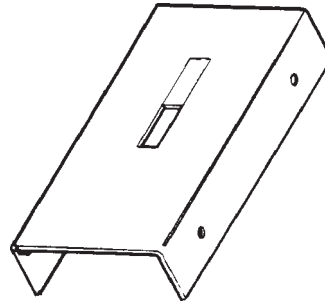

### DOUBLE DOOR STYLE GUARD—K-15

Finally a better way to secure a set of double doors!! 12 gauge steel increases security and can repair doors that have already been attacked. 7-3/4" long, for 1-3/4" doors. Designed with knock out feature to make a W&F into an Adams Rite

Stock No.	Finish
KD-K-15A 626	Aluminum Finish
KD-K-15B 613	Duronotic Finish

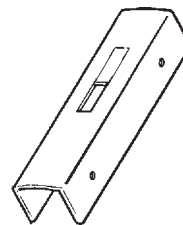

### OFFSET STYLE GUARD—K-20

To complete our style guard line we finally have a guard for the offset aluminum door or doors that swing one way with jamb stops. 7" long. This non-handed guard is easy to install and comes with pop rivets and carriage bolts.

Stock No.	Finish
KD-K-20A 626	Aluminum Finish
KD-K-20B 613	Duronotic Finish

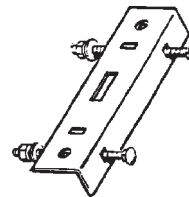

### CYLINDER GUARD RING—K-24

Hardened steel, free spinning, tapered cone shaped cylinder guard. Works with both 5 and 6 pin cylinders. Kit includes 6 of each: ring, stainless steel wave washer and spacing collar.

Stock No.	Finish
KD-K-24A 626	Aluminum Finish
KD-K-24B 613	Duronotic Finish

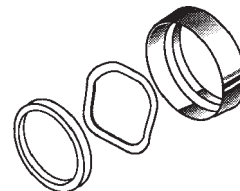

### PROTECT-A-LOK—K-12

Finally a product designed to protect locks from impact damage. The Keedex KD-K-12 Protect-A-Lok, made from U.L. approved Lexan plastic, is virtually indestructible by impact. Designed for use in areas where locks may have a chance of getting hit by carts, forklifts or moving vehicles. Can be used with levers, knobs or panic hardware with any size backset. Installs in minutes. Guaranteed for 5 years.

Stock No.	Finish
KD-K-12	Cream Finish
KD-K-12D	Duronotic Finish

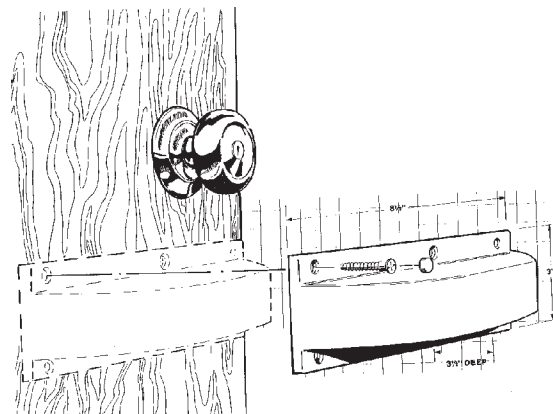

**Ideal for Super Markets, Warehouses, Hotels, Hospitals, Restaurants and more.**

©ZIPF LOCK COMPANY

# DOOR & CYLINDER GUARDS

## HEAVY DUTY GUARD PLATE



### VDG-10

The VDG-10 is the strongest and most popular guard plate. It is 14" long and is made from 2 pieces of 16 gauge cold rolled steel, welded together with a baked Matte Bronze finish.

This guard plate offers maximum resistance to prying and forcing. It mounts onto your door with 2 carriage bolts going through the door and anchored with a nut and cap nut on the inside. Four wood screws go into the edge of the door. Guard plates come complete with all necessary hardware and illustrated instructions.

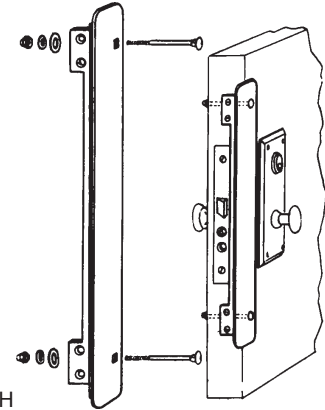

1-3/4"W x 14"H

PROTECT AGAINST  
BREAK-INS!!

## LATCH-GARD®

**Finishes:**  
**BB-** Bright Brass  
**D-** Duranodic  
**Z-** Zinc Plated

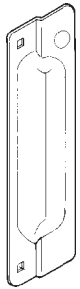

3" x 11"  
**LG-100**



3" x 11"  
**LG-110**



1-1/2" x 6"  
**LG-120**



1-1/2" x 10"  
**LG-130**



2-1/2" x 10"  
**LG-140**



2-5/8" x 6"  
**LG-150**



12" x 2-5/8"  
Fits Adams Rite  
**LG-160**

1-7/8" x 12"

**LG-170**  
3/8" offset

**LG-171**  
1/2" offset

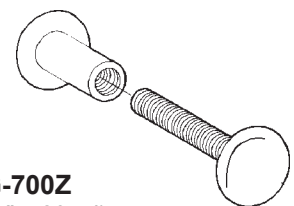

**LG-700Z**  
(1/4" x 20 tpi)  
with screw

**LG-710Z**  
(5/16" x 18 tpi)  
with screw

**TO ORDER:** Specify Guard No. and Finish.

**LG-100 + BB = LG-100-BB**

# DOOR & CYLINDER GUARDS



**LORI**

## "THE BLOCKER"

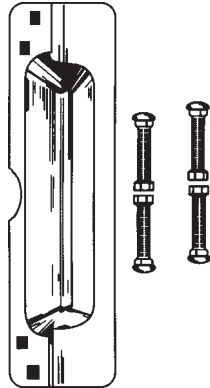

**Application:** The Blocker® discourages forced entry attempts on outswinging doors. 3" x 10-7/8"

**Stock No.** Finish  
**\$LOR-1100 DU** Duranodic

## "THE SUPER BLOCKER" FOR ALUMINUM DOORS

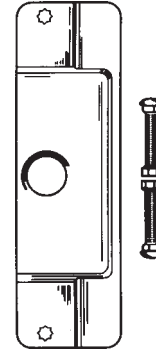

**Application:** The Super Blocker® is designed for narrow style aluminum doors. Reversible. Complete with 2 sex nuts. 3-1/2" x 12"

**Stock No.** Finish  
**\$LOR-1120 AL** Aluminum

## CAL-ROYAL

**CR-LPG2**  
 Latch Guard  
 Finishes:  
 ALUM, DURO,  
 GOLD, USP

2-7/8" x 11"



**Stock No.** Finishes  
**MAG-8840-B** Brass  
**MAG-8840-C** Chrome

*Latch Guard 7", for In-Opening doors.* All backsets, Deadbolts and Key-in-knobs locks. Reinforces door and frame, prevents spreading of frame, hardened conealed screws. 14GA. U.S. Pat. 5,395,145

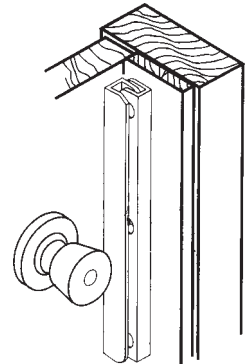

**Stock No.** Finishes  
**MAG-8843-B** Brass  
**MAG-8843-C** Chrome

*Latch Guard 12", for In-Opening doors.* All backsets, Deadbolts and Key-in-knobs locks. Double locks, Mortise Locks & Access control locks. Reinforces door and frame, prevents spreading of frame, hardened conealed screws. 14GA. U.S. Pat. 5,395,145

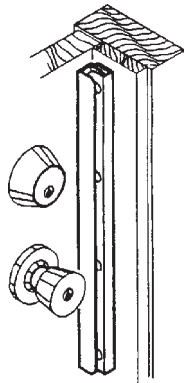

**Stock No.** Finishes  
**MAG-8845-B** Brass  
**MAG-8845-C** Chrome

*Latch Guard 6", for Out-Opening doors.* All backsets, Deadbolts and Key-in-knobs locks. Protects latch or bolt, heavy gauge steel. Accepts up to 3-1/2" rose, 7/16" offset. 12 GA.

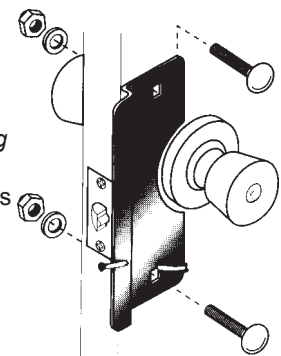

# DOOR & CYLINDER GUARDS



**Stock No.**      **Finishes**  
**MAG-8848-B**    Brass  
**MAG-8848-C**    Chrome

*Latch Guard Heavy Duty 7"*, for Out-Opening doors. All backsets, Deadbolts and Key-in-knobs locks. Protects latch or bolt. Conceals lip if existing strike. Accepts up to 3-1/2" rose. 12 GA.

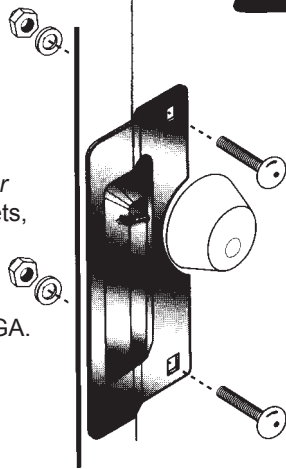

**Stock No.**      **Finishes**  
**MAG-8850-B**    Brass  
**MAG-8850-C**    Chrome

*Latch Guard Universal 11-3/4"*, for Out-Opening doors with 1" x 8-3/4" Cutout. All backsets, single locks, double locks up to 6" on center, combination locks, mortise locks & access control locks. Protects latch and bolt, conceals lip of existing strike. Reinforced mounting area. 12GA. with anti-spread pin. U.S. Pat. 5,415,020.

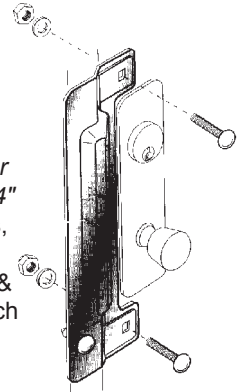

**Stock No.**      **Finishes**  
**MAG-8852-AL**    Aluminum  
**MAG-8852-DU**    Duronodic

*Latch Guard 6-1/2"*, for Out-Opening doors. Narrow stile, store front doors with cylinder guard and drive rivet, 3/16" offset with 1/2" clearance under channel. 12GA.

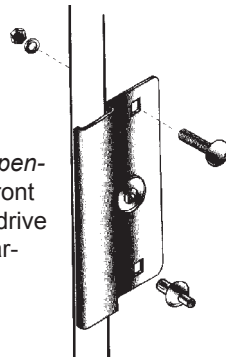

**Stock No.**      **Finishes**  
**MAG-8854-AL**    Aluminum  
**MAG-8854-DU**    Duronodic

*Latch Guard 12", Removable* (for flush doors). With anti-spread pins for single or double acting doors with cylinder guard. 12GA. U.S. Pat. 5,547,239.

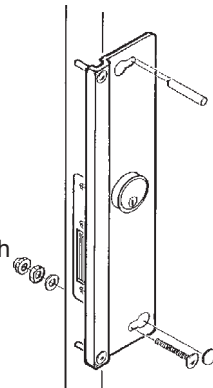

**Stock No.**      **Finishes**  
**MAG-8855-AL**    Aluminum  
**MAG-8855-DU**    Duronodic

*Latch Guard 12", Removable* (for center hung 4" frame). With anti-spread pins for center hung doors, 1-1/8" offset for 4" frame with cylinder guard, for single or double acting. 12GA. U.S. Pat. 5,547,239.

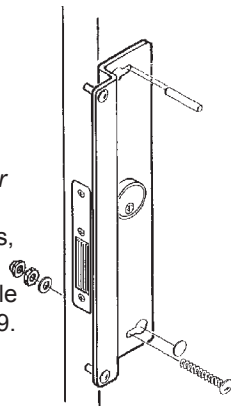

# MISCELLANEOUS

## DOOR BOLTS

### Decorative Surface Bolts

- Features attractive 1/2" half-round rods and well-proportioned guides.
- Semi-concealed guides assure smooth operation and are positioned under the rod to eliminate marring the surface of the bolt.
- Stainless steel tension spring prevents rod disengagement from guide and provides tension to hold bolt in desired position.
- Decorative **3/4" diameter knob** designed to facilitate bolt operation.
- Made from burnished steel.
- Available in 6" length.
- Packed with both Universal and Angle Strikes.
- Meets design requirements of ANSI/BHMA A156.16.
- Dimensions: Throw: 1"; Projection: 15/16"; Half Round Rod: 1/2"; Overall Width: 1-3/8".

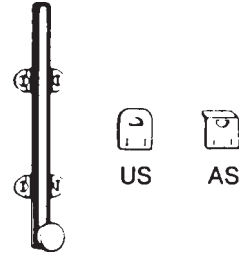

**Stock No. (Specify Finish & Length)**  
**IV-43F3 6"** 6" length - Steel  
**Finishes: 3**

### Dutch Door Bolts

- Practical, rugged, attractive bolt for application on dutch doors as well as other areas.
- Chamfered rod end draws the two leaves of door tightly together.
- Sufficient tolerance provided in strike opening to allow for misalignment of door leaves and also prevents binding of bolt.
- Decorative 1" diameter knob designed to facilitate bolt operation.
- Made from solid brass.
- Packed with Standard Strike.
- Dimensions: Throw: 5/8"; Projection: 1-1/8"; Half Round Rod: 5/8"; Overall Width: 1-5/8"; Rod Length: 4-1/4"; Overall Length, including knob: 4-3/8"

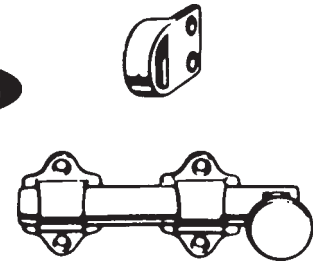

**Stock No. (Specify Finish & Length)**  
**IV-054MB** 6" length - Steel  
**Finishes: 3, 26D**

### Surface Bolt

- Surface Bolt has 1-3/16" throw for maximum security.
- Strong tension springs prevent creep.
- Ideal for all types of doors.
- Available 12" length. (8", 18" and 24" by special order)
- Unit packed with standard screws for added security.
- Unit packed with both a universal top strike (T) and a mortise bottom strike (B).
- Constructed of heavy duty steel.
- 8" and 12" Bolts are UL listed up to 3 hours when used on the inactive door of a pair up to 10' in height.
- Meets ANSI/BHMA A156.16 L84161
- Dimensions: Bar: 3/4" Wide x 1/4" Thick; Overall Width: 2-1/32"; Overall Projection: 1-5/16"  
 Top Strike: 1-1/2" x 1-1/2" Angle, 3/16" Thick; Bottom Strike: 3-1/2" Long x 1-5/8" Wide x 1/8" Thick.

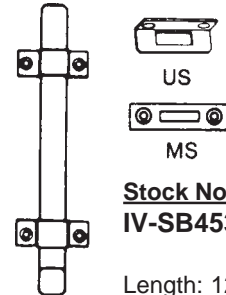

**Stock No.**  
**IV-SB453-12-TB 26D**

Length: 12"  
 Finishes: 26D

## Master Lock

### DUAL FUNCTION DOOR SECURITY BAR

Adjusts to fit most Sliding and Hinged doors

Non-marring yoke (removable for sliding doors)  
 Designed to fit most doors, simple push button adjustment.  
 High strength steel tube. 20-gauge.  
 Portable. Collapsible, to fit most suitcases and garment bags.  
 Pivoting ball joint for full contact on floor.  
 Padded foot provides sure grip on most floors.  
 Lifetime Guarantee.

**Stock No.**  
**265D (White)**

For Sliding Doors

For Hinged Doors

© ZIPP LOCK COMPANY

## DOOR CHAINS

### CAL-ROYAL

**CR-DG22**

US3 Solid Brass  
 Chain Door Guard  
 6-3/4" Chain



## DOOR GUARDS

### CAL-ROYAL

**CR-BBDHG88**

US3, 26D  
 Zinc Diecast Swing Bar  
 Door Guard with  
 ball bearing  
**Limited supply of US-5.**  
**Call for closeout price.**

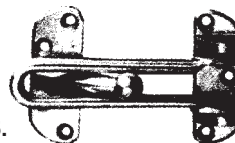

### FLIP LOCK MAG-8705

For in-opening doors. Left or right hand.  
 Heavy gauge steel.



# MISCELLANEOUS

## DOOR GUARDS

**IVES**

- Solid Bar Door Guard is for use on doors that are flush with frames.
- The solid bar, interlocking with the ball on the strike plate, permits the door to be slightly opened to allow viewing.
- The hinged bar allows the door guard to be positioned 180° away from the door when not in use.
- Edge guard, furnished with cast brass door guards, minimizes the chance for marring the door or frame.
- Strike plate is designed to prevent the solid bar from marring the inside of the door when in use.
- Easy installation.
- Meets ANSI/BHMA A156.16.
- Made from cast brass or cast aluminum.
- Packed with sheet metal screws.
- Dimensions of Cast Brass Door Guard: Strike Plate: 2-5/8" x 1-1/32"; Holder: 1-3/4" x 1-1/16"; Arm Length: 4-3/4"; Edge Guard: 1-1/8" x 1-1/32"
- Dimensions of Cast Aluminum Door Guard: Strike Plate: 2-1/2" x 7/8"; Holder: 2-1/2" x 15/16"; Arm Length: 3-13/16".

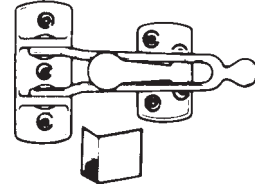

**Stock No. (Specify Finish)**

**IV-482A** Cast Aluminum

Finishes: 3, 26D

**IV-482B** Cast Brass

Finishes: 3, 5, 10B, 15, 26, 26D

## DON-JO

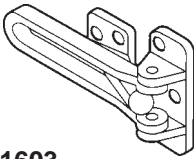

**DJ-1603**

Finishes: 605, 625, 626  
Material: Aluminum. Edge protector included (1" x 1" x 1/2").  
ANSI L33042.

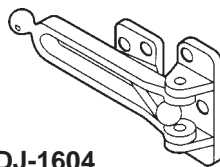

**DJ-1604**

Finishes: 605, 625, 626  
Material: Brass. ANSI L13042.

## DOOR SILENCERS

### CAL-ROYAL

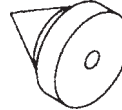

**CR-DSM21**

Rubber Door Silencer.  
1/2" Dia. 11/16"  
Length. For metal frames  
(Sold in bags of 100)



**CR-DSW85**

Rubber Door Silencer.  
3/8" x 3/4" Base, 3/4" length. For wood frames  
(Sold in bags of 100)

## DOOR VIEWERS

### CAL-ROYAL



160° Door Viewer  
1/2" Bore

**CR-DV90** (plastic lens)

US3, 10B, 15, 26

**CR-ULDV160\*** (glass lens)

US3, 26

\*UL Listed



Door Viewer  
9/16" Bore

**CR-DV180** 180° (plastic lens)

US3, 5, 10B, 15, 26

**CR-ULDV200\*** 200° (glass lens)

US3, 10A, 26

\*UL Listed

**IVES**

### One-Way Wide Angle Viewer

- 190° Angle of View.
- Lens projects 1/4" from face of door.
- 4 optical glass lenses.
- For doors 1-3/8" to 2-1/8" thick.
- Solid brass body and barrel.
- Simple installation — only a 9/16" hole required.
- Conforms to ANSI/BHMA A156.16 L23172 and L23222.
- Suggested installation height: 60" from floor.

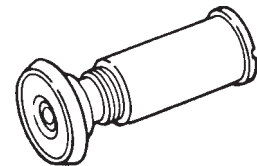

**Stock No. (Specify Finish)**

**IV-698B**

Finishes: 3, 26D

### One-Way Viewer

- 120° Angle of View.
- For doors 1-3/8" to 2-1/16" thick.
- Secure, tamper-resistant.
- Solid brass body; glass lens.
- Simple installation — only a 1/2" hole required.
- Suggested installation height: 60" from floor.
- Conforms to ANSI/BHMA A156.16 L23173.

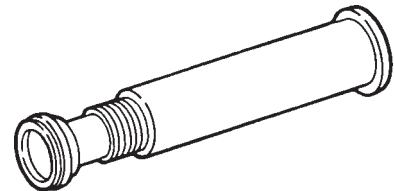

**Stock No. (Specify Finish)**

**IV-700B**

Finishes: 4, 26D

©ZIPF LOCK COMPANY

See page 427 for Cal Royal, Don Jo, Ives finish descriptions.

435v1  
(PL-42)