

# FILE CABINET LOCKS

- Four Pin tumbler plug.
- Satin Chrome finish.
- Die Cast barrel with die cast bolt.
- 5002LP has rectangular bolt.
- Other models have round bolt.
- 2 keys per lock.

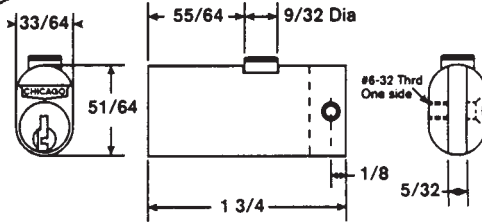

| Stock No.  | Description   |
|------------|---|
| C5001LP KV | Keyed Different*  |
| C5001LP KA | Keyed Alike: SPECIFY KA#<br>1x03, 1x04, 1x20, 2x01, 2x02, 3x5 |

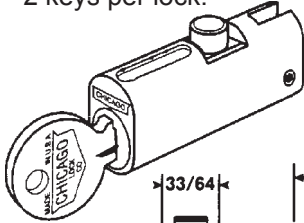
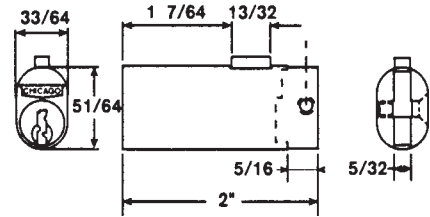
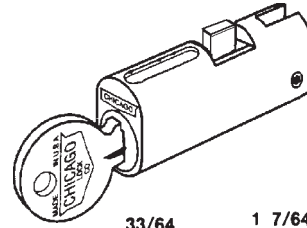

| Stock No.  | Description   |
|------------|---|
| C5002LP KV | Keyed Different*  |
| C5002LP KA | Keyed Alike: SPECIFY KA#<br>1x03, 1x04, 1x20, 2x01, 2x02, 3x5 |

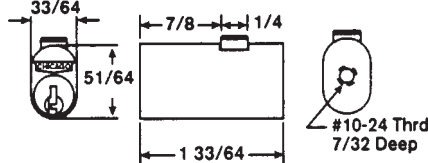
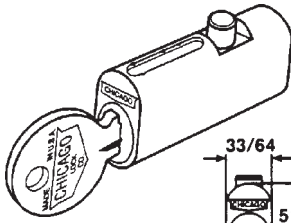

| Stock No.    | Description       |
|--------------|-------------------|
| CEXP-19DC KV | Keyed Different*  |
| CEXP-19DC KA | Keyed Alike: 5x75 |

\*KV indicates the majority of the quantity of locks will be keyed different. A lesser quantity will potentially be keyed alike to one or more key numbers. We can not guarantee that we can ship keyed DIFFERENT locks.

## PIN TUMBLER FILE CABINET LOCK



**APPLICATION**—Used internally on filing cabinets to gang lock drawers.

**OPERATION**—Key removable in locked position only.

**KEYING**—Will key together with all other pin tumbler locks using D4291 key blank except NL-C8700 series mail box locks. Available keyed different (KD) or keyed alike (KA# 107).

**KEY BLANK**—D4291.

**PACKAGING**—Supplied with two keys.

**FINISHES**—26D-Dull Chrome.

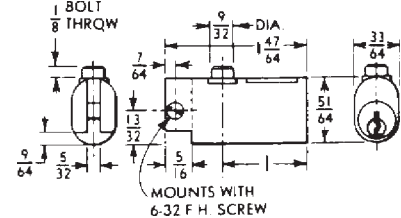
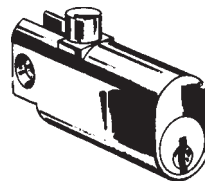

NL-C8150-26D

| Stock #      | Installation | Bolt Type | Cylinder Length | Bolt Travel | Keyed Alike Numbers Available |
|--------------|--------------|-----------|-----------------|-------------|-------------------------------|
| NL-C8150-26D | File Cabinet | Spring    | —               | 1/8"        | 107, 915                      |

Available KD-Keyed Different or KA-Keyed Alike. Specify KD or KA

# FILE CABINET LOCKS

## DISC TUMBLER FILE CABINET LOCK

**APPLICATION**—Used internally on filing cabinets to gang lock drawers.

**OPERATION**—Key removable in locked position only.

**KEYING**—Keyed only to "Pundra" keyway.

**KEY BLANK**—D8776.

**PACKAGING**—Supplied with two keys.

**FINISHES**—26-Bright Chrome.

**CompX**  
NATIONAL

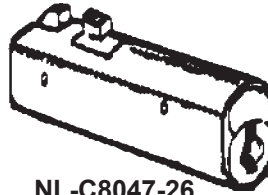

NL-C8047-26

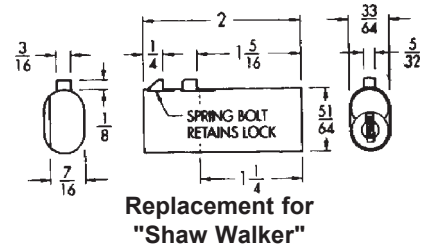

| Stock #     | Installation | Bolt Type | Cylinder Length | Bolt Travel | Keyed Alike Numbers Available |
|-------------|--------------|-----------|-----------------|-------------|-------------------------------|
| NL-C8047-26 | File Cabinet | Spring    | —               | 1/8"        | P141A                         |

Available **KD**-Keyed Different or **KA**-Keyed Alike. *Specify KD or KA*

## ES-1750 Series Pin Tumbler File Cabinet Locks



- 4 pin tumbler cylinder.
- Regularly furnished with 2 keys, ES1 key blanks.
- Available keyed alike (KA) or keyed different (KD).

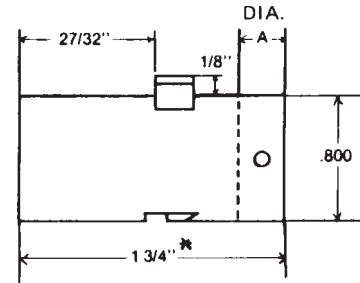
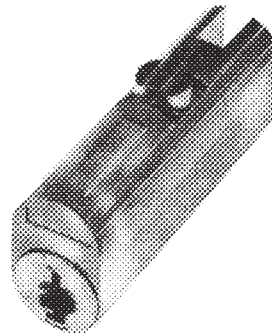
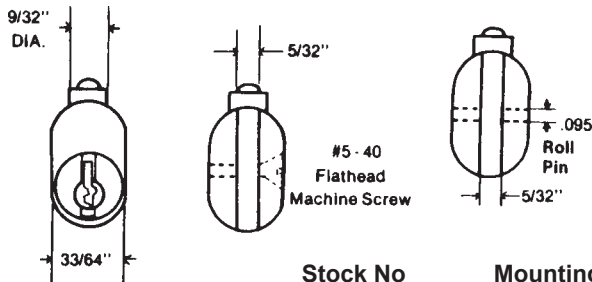

| Stock No    | Mounting      | "A" Dimension | Keyed Alike Number Available |
|-------------|---------------|---------------|------------------------------|
| ES-1750P312 | roll pin      | 5/16"         | L009                         |
| ES-1750S312 | machine screw | 5/16"         | L009                         |
| ES-1750P500 | roll pin      | 1/2"          | L006                         |
| ES-1750S500 | machine screw | 1/2"          | L008                         |

**TO ORDER:** Specify Stock No. and keying (KA or KD)

**NOTE:** 312 Series replacement for Hon. Equivalent to Chicago 5001LP.  
500 Series replacement for Anderson Hickey. Equivalent to Chicago 5001-50LP.

## CHROME FILE CABINET LOCK

- Single bitted.
- Keyway: HL1
- 1-3/4" length.

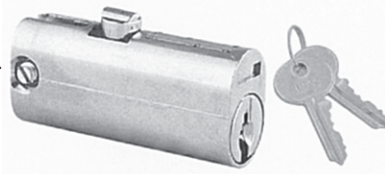

**TET**

**CONVERSION CHART**  
For **FD1341**:  
Chicago: C5001-LP  
ESP: 1750S312  
National: C8150  
For **FR1341**:  
ESP: 1750S500

| Stock No. | Slot Depth | Keyed Alike Number Available |
|-----------|------------|------------------------------|
| JT-FD1341 | 1/2"       | L009                         |
| JT-FR1341 | 5/16"      | L009                         |

Available **KD**-Keyed Different or **KA**-Keyed Alike.  
*Specify KD or KA*

## PRO-LOK®



**PK-LTFC9505**  
**Fire Cabinet Lock**

Self contained trip lever cylinder lock assembly fits glass fire cabinet doors. Keyed alike LL24.

©ZIPF LOCK COMPANY

# FILE CABINET LOCKING BARS

## ABUS

There is a rolling design change on the bar. The new bar has a powder-coated finish and knob in center of bar for easy and smooth operation.

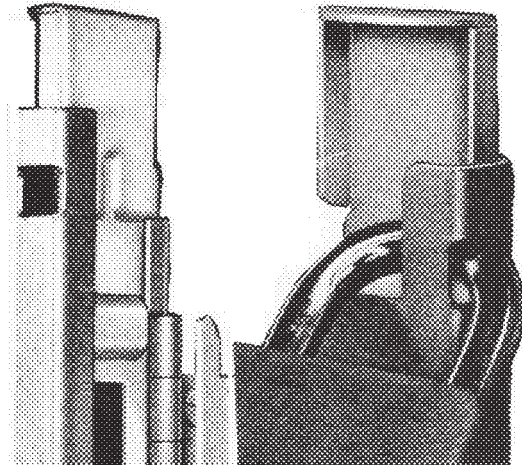
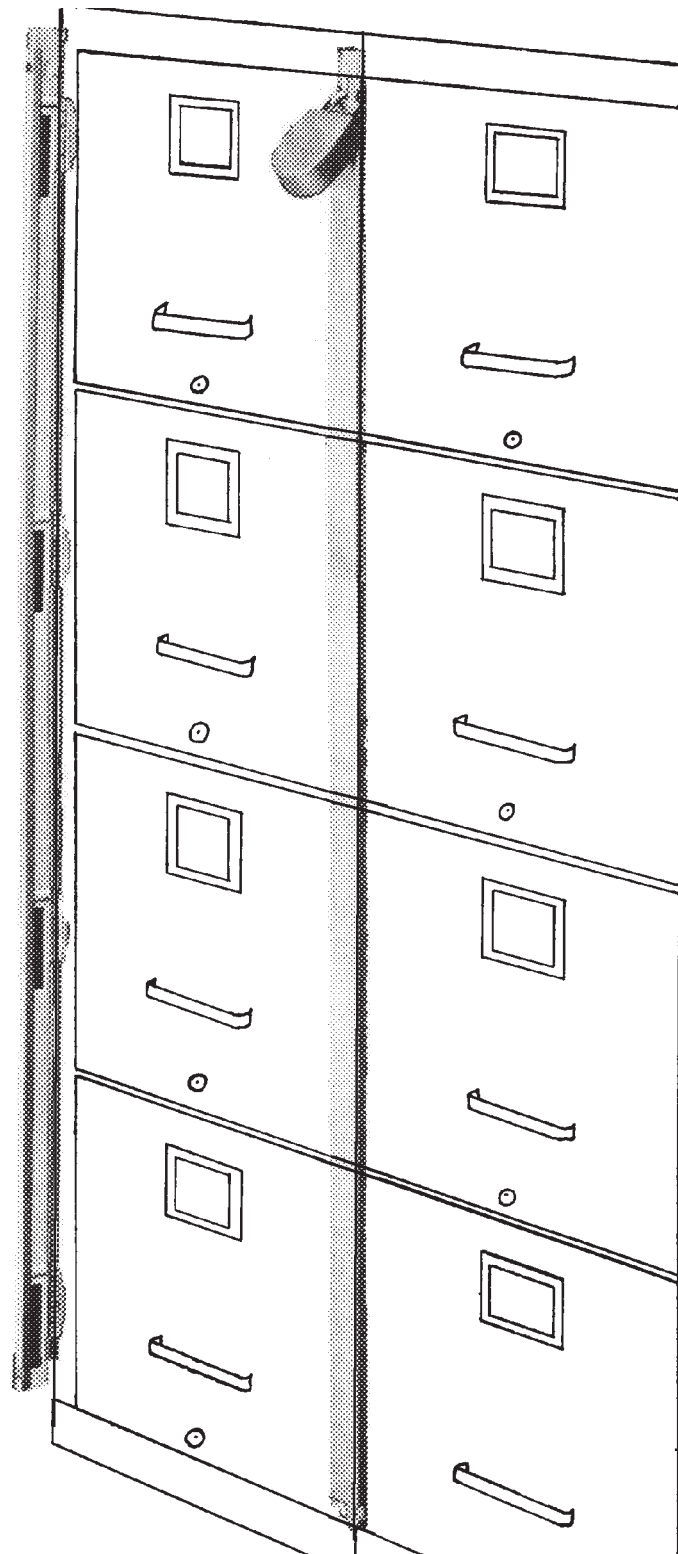

| NUMBER | LENGTH  |
|--------|---------|
| ML-1   | 11"     |
| ML-2   | 21-1/2" |
| ML-3   | 33-1/2" |
| ML-4   | 45"     |
| ML-5   | 56"     |

Stock # & number of drawers are the same.

### Multi-point locking design

Red inner slide bar interlocks with specially designed locking lug hinge at each drawer opening when in locked position. This multiple point locking principle eliminates torque on the bar usually found in devices that lock at the top and bottom position only.

### Spring-open action

A slight upward motion of the red inner slide bar releases all lock points, permitting the built-in spring-loaded hinge to swing bar clear of drawer openings. Engineered to give sufficient clearance for unrestricted access to adjacent files when locked or unlocked.

### No storage—accident—damage problem

Since Multi-Lock bars become an integral part of the file and swing clear of drawer openings, they solve the problem of storing heavy, dangerous bars in the office.

### Simple installation

Can be installed with blind rivets provided or steel metal screws\*. Whichever method is used, the integrity of the fastener is protected, since the points of attachment are completely covered by the bar in the closed position, effectively preventing surreptitious entry. Multi-Lock can be installed without opening the file or disturbing the contents—in a matter of minutes.

Drill upper rivet hole(#20 — .161 diameter) 2-3/8" down and 1/4" over from the upper drawer opening. Insert and set rivet to hold bar in place. Use hinges as locators for other holes. Drive rivets home while keeping hinges firmly in place against file.

The inner slide bar can be reversed to permit installation on either right or left side of file cabinet(normally supplied for left side installation). \*If installation with sheet metal screws if preferred, use #8 X 3/8" pan head, type A.

### SPECIFICATIONS

Constructed of heavy 16-gauge formed steel. Chrome plated. Inner slide bar finished in red thermosetting acrylic enamel. All hinges and locking lugs are of 16-gauge steel. Chrome Plated. 5/32" diameter cherry rivets supplied.

©ZIPF LOCK COMPANY

# FILE CABINET LOCKING BARS



## SWING-A-WAY

There are no clutter problems with the self-contained Swing-A-Way Locking Bar. The bar remains permanently on the file whether or not the file is in use. Heavy duty cold rolled steel gives the Swing-A-Way Locking Bar strength where it is needed. The bars are cadmium plated to permit their use with any color combination. Red signal tape is attached to the backside of each bar to prevent scratches on painted surfaces and to indicate when the bar is in an open position.

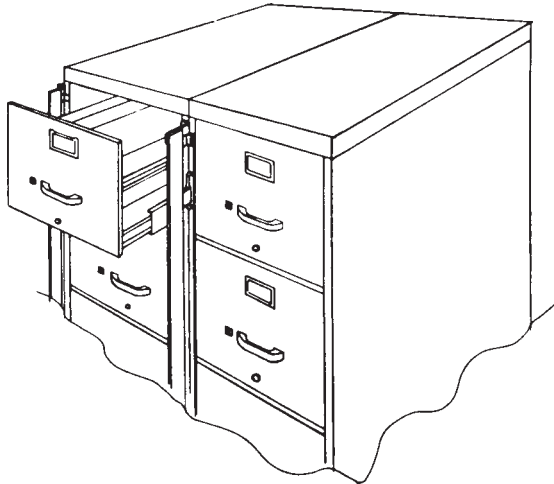

**FULL HEIGHT  
DESK PEDESTAL**

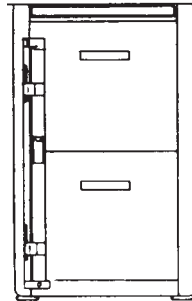

**REGULAR  
DESK PEDESTAL**

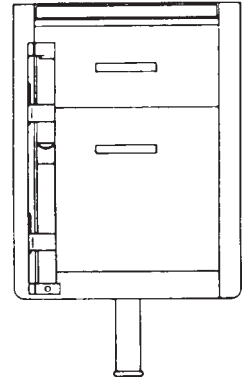

Installed on left side of all filing cabinets. Will not interfere in any way with adjoining files. Available to fit 2, 3, 4 or 5 drawer files.

**DRAWING #1**

**DRAWING #2**

Swing-A-Way Locking Bars may be ordered for either full height pedestals or regular pedestals. As with filing cabinets, Locking Bar is installed on left side of the desk pedestal.

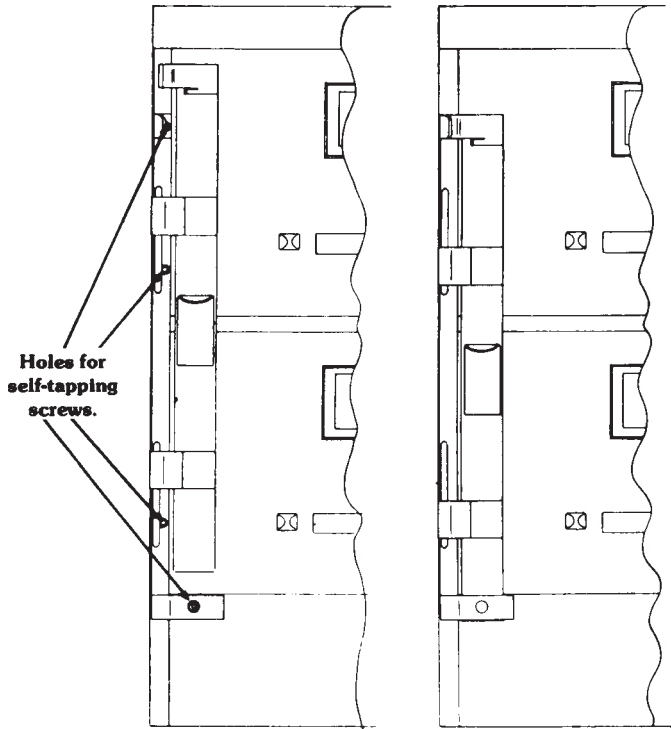

### INSTALLATION

To install—place locking bar as shown in Drawing #1. Drill holes in file or desk pedestal to coincide with holes in the bar. Drill size 7/64" should be used to drill holes for #6 self-tapping screws(enclosed). After screws have been installed and the bar moved to the locked position, the screw heads are inaccessible as shown in Drawing #2.



**DRAWING #3**

The above drawing shows the locking bar in an open position. Note the positive stop which holds the unlocked bar in position while file or desk is in use.



**DRAWING #4**

Above drawing shows bar in locked position ready to receive padlock.

| <u>Left Hand</u><br><u>Stock No.</u> | <u>Right Hand</u><br><u>Stock No.</u> | <u>Length</u> | <u>Description</u>    |
|--------------------------------------|---------------------------------------|---------------|-----------------------|
| FB-1L                                | FB-1R                                 | 18-3/4"       | For desk drawers      |
| FB-2L                                | FB-2R                                 | 23-1/2"       | For 2 drawer cabinets |
| FB-3L                                | FB-3R                                 | 33"           | For 3 drawer cabinets |
| FB-4L                                | FB-4R                                 | 49-1/2"       | For 4 drawer cabinets |
| FB-5L                                | FB-5R                                 | 55"           | For 5 drawer cabinets |