

ORIGINAL CYLINDER KEY BLANKS

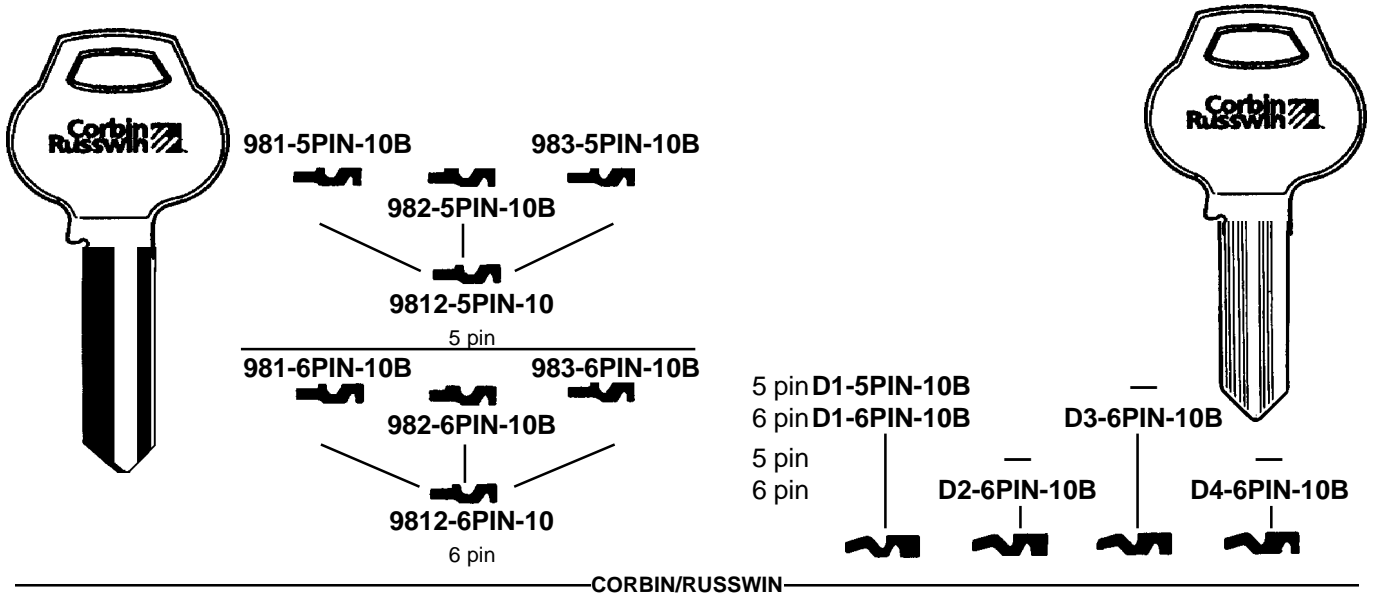

NOTE: Fort blanks may not be actual size.

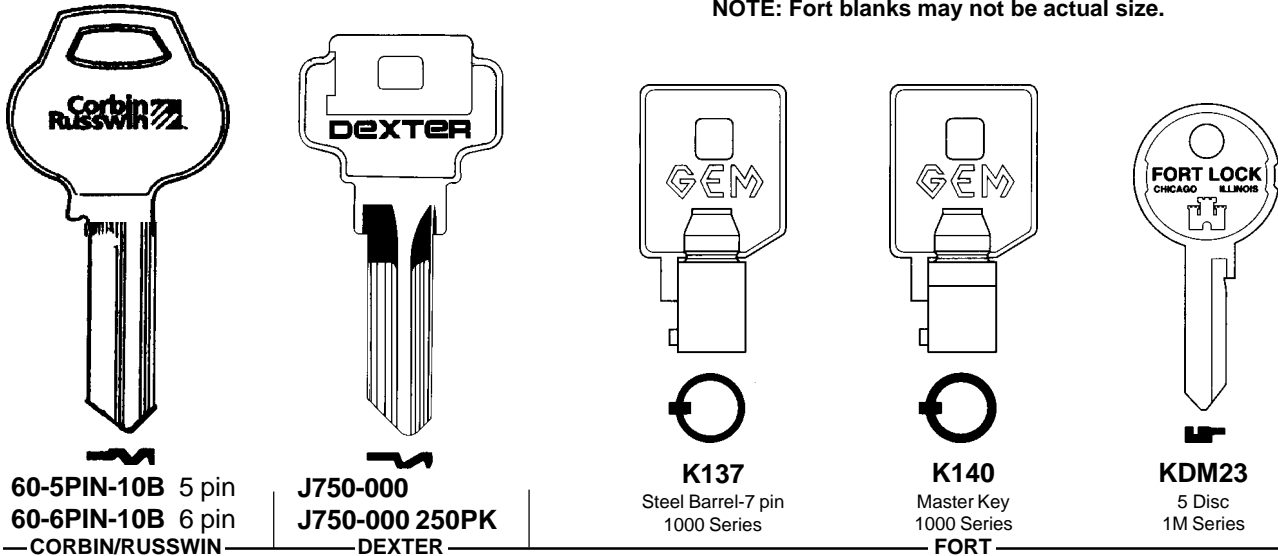



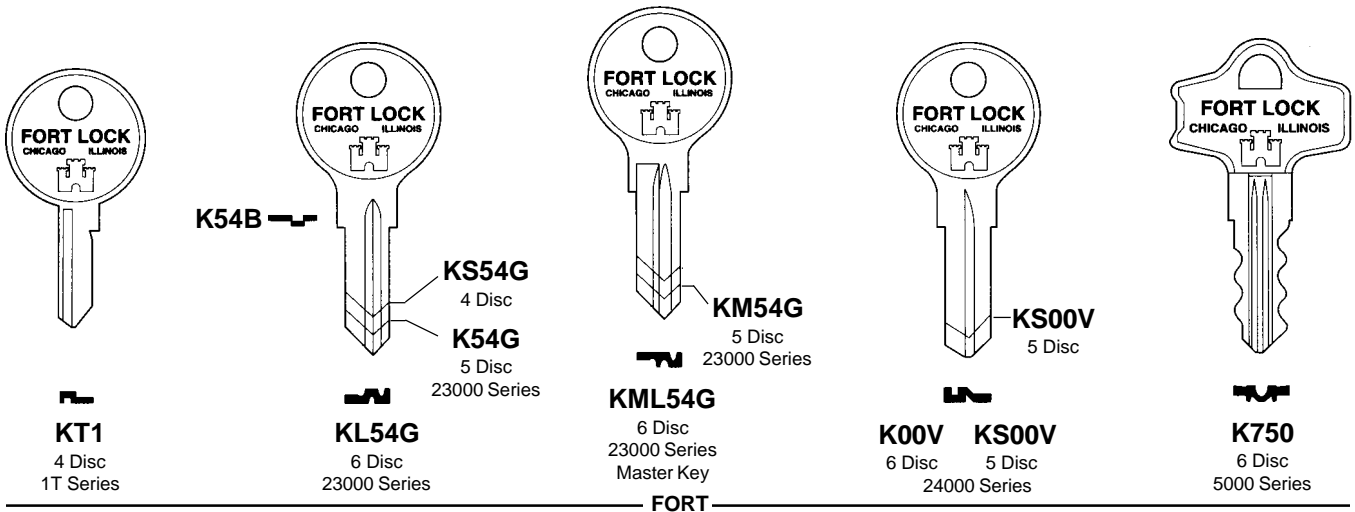





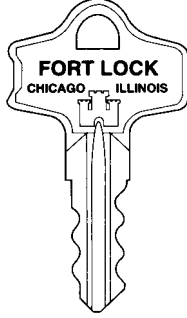
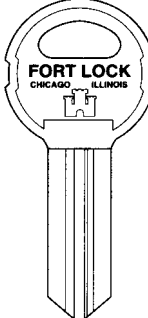
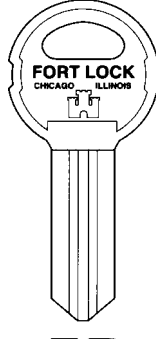
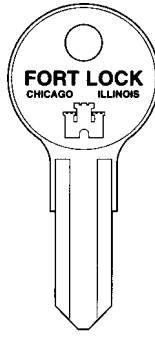

NOTE: Fort blanks may not be actual size.











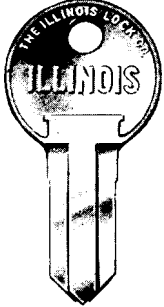

ORIGINAL CYLINDER KEY BLANKS

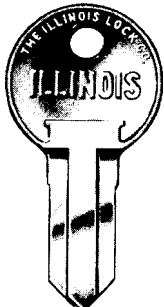
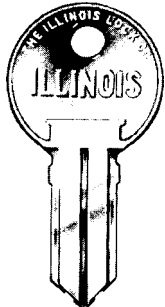
NOTE: Fort blanks may not be actual size.







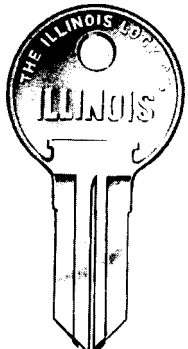
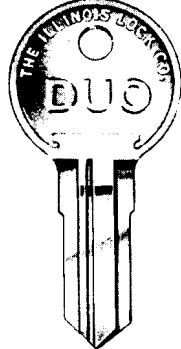

					
					
K757 6 Disc 5000 Series	K84 10 Disc 16000 Series	K84M 10 Disc 16000 Series Master Key	K60 10 Disc 7000 Series	K752 6 Disc 8000 Series	K775 6 Disc 9000 Series

KS900
5 Disc
29000 Series

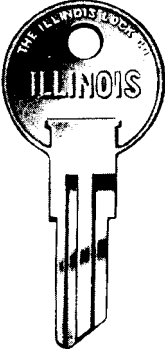
FORT







					
					
100	105	110	115	310	220

ILLINOIS

				
				
210	3027-1-X (X410)	260	360	360M

ILLINOIS

ILCO CYLINDER KEY BLANKS

						
5 pin	1054WD (1)	1054WH	1054WK	1054WL	1054WN	1054WP
6 pin	A1054WD	A1054WH	A1054WK	A1054WL	A1054WN	A1054WP

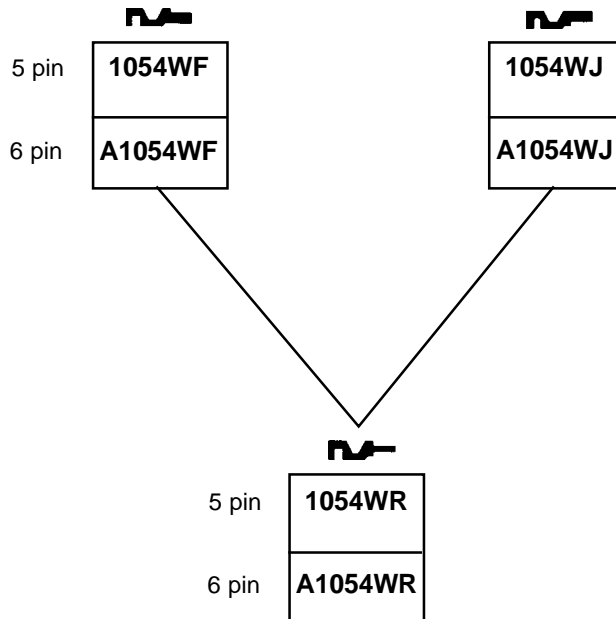
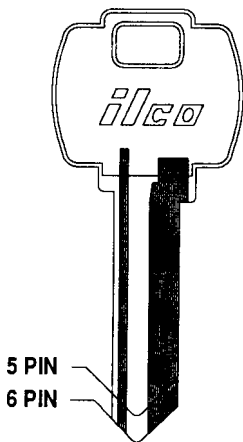



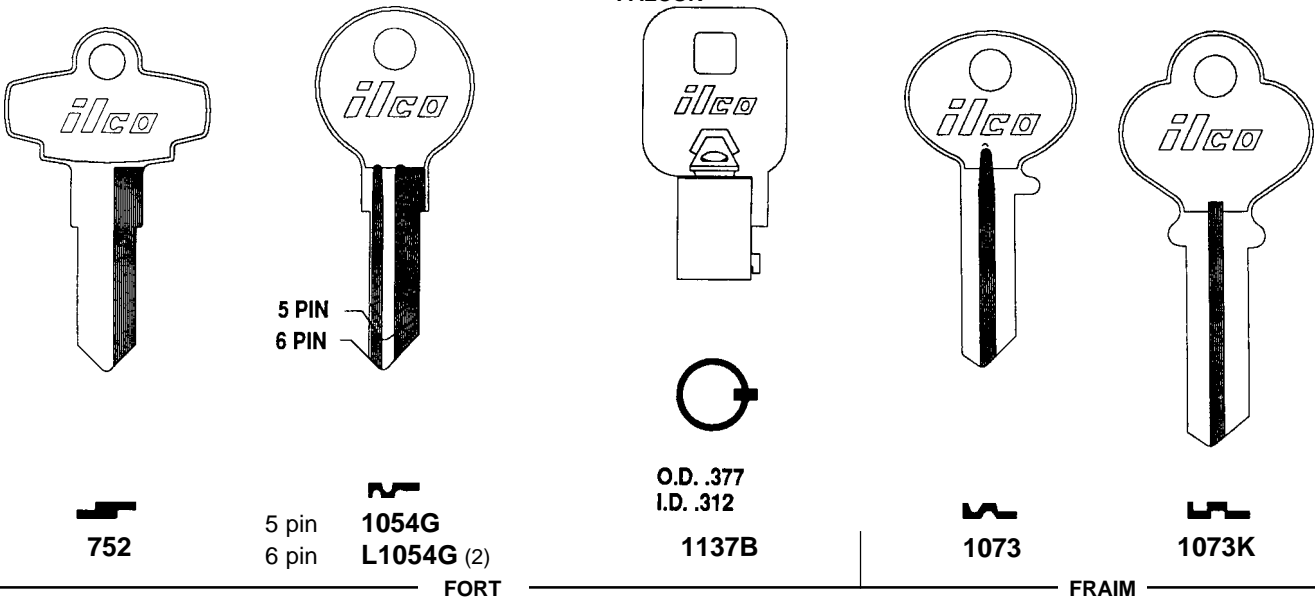





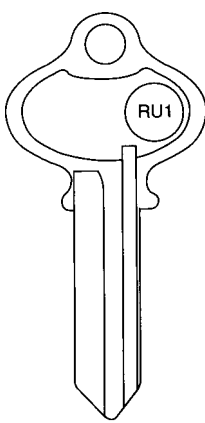
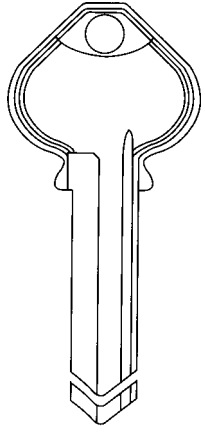
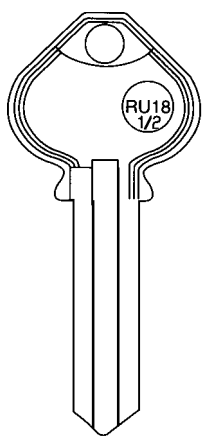
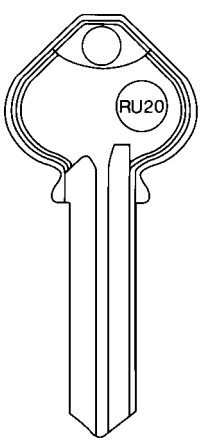
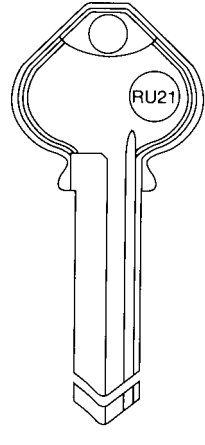
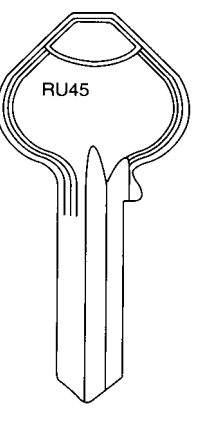



FALCON



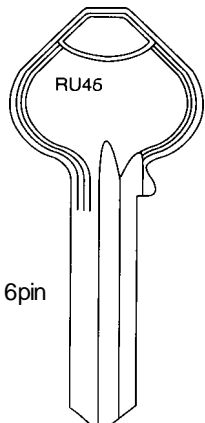
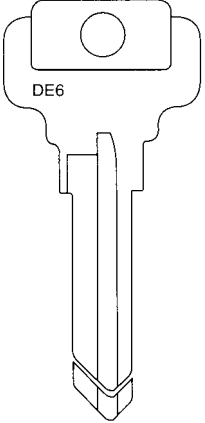
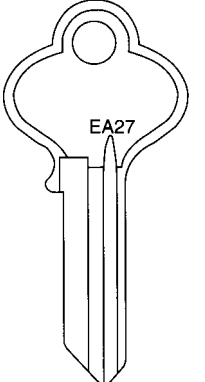
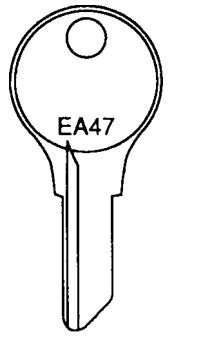
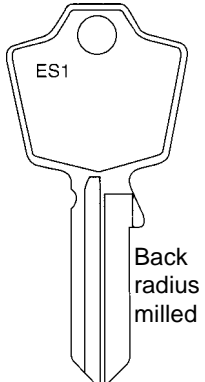



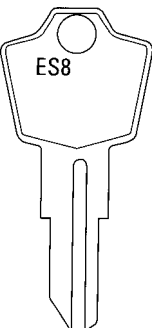
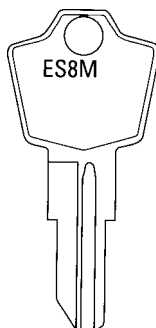
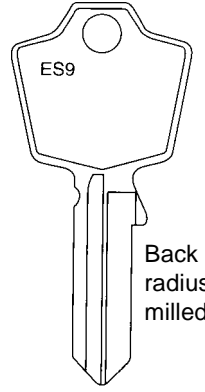
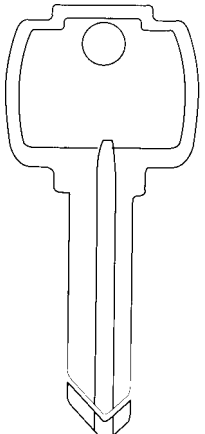
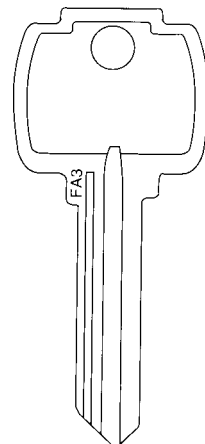
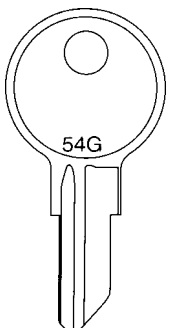

1 - Available in Look Alike, see pages 1070-1072.
 2 - Available in Taylor Line®, see page 1073.
 3 - Available in Bin Pack, see page 1074.

JET CYLINDER KEY BLANKS

 <p style="text-align: center;">RU1</p>		 <p style="text-align: center;">RU18 1/2</p>	 <p style="text-align: center;">RU20</p>	 <p style="text-align: center;">RU21</p>	 <p style="text-align: center;">RU45</p>
 JT-RU1	 5 pin JT-RU4 6 pin JT-RU16	 JT-RU18-1/2	 JT-RU20	 5 pin JT-RU21 6 pin JT-RU22	 JT-RU45 1 JT-RU45-250 (250 Blanks in Bulk Pack)
CORBIN/RUSSWIN					

 <p style="text-align: center;">RU46</p> <p style="text-align: center;">6pin</p>	 <p style="text-align: center;">DE6</p>	 <p style="text-align: center;">EA27</p>	 <p style="text-align: center;">EA47</p>	 <p style="text-align: center;">ES1</p> <p style="text-align: right;">Back radius milled</p>
 JT-RU46 1 JT-RU46-250 (250 Blanks in Bulk Pack)	 5 pin JT-DE6 1 JT-DE6-250 (250 Blanks in Bulk Pack)	 JT-EA27	 JT-EA47	 JT-ES1
CORBIN/RUSSWIN	DEXTER	EAGLE		ESP

 <p style="text-align: center;">ES8</p>	 <p style="text-align: center;">ES8M</p>	 <p style="text-align: center;">ES9</p> <p style="text-align: right;">Back radius milled</p>		 <p style="text-align: center;">FA3</p>	 <p style="text-align: center;">54G</p>
 JT-ES8	 JT-ES8M	 JT-ES9	 5 pin JT-FA1 6 pin JT-FA2	 JT-FA3	 JT-54G
ESP			FALCON		FORT

1 - Available in Uni Bow Head, see page 1090

JET CYLINDER KEY BLANKS

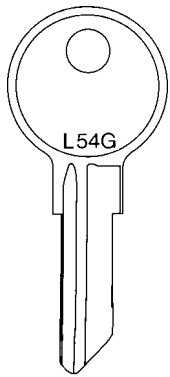

L54G

JT-L54G

FORT

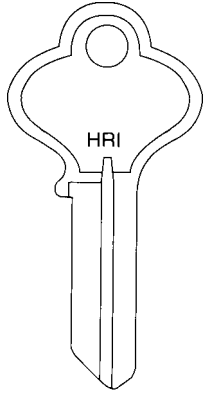

HRI

JT-HR1

HARLOC

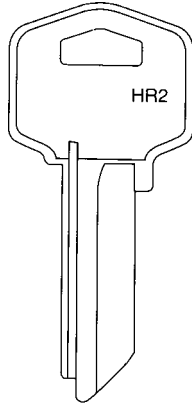

HR2

JT-HR2

HAWORTH

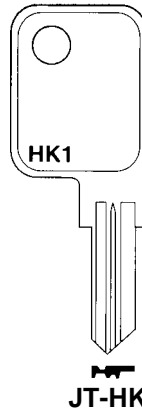

HK1

JT-HK1

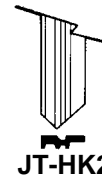

JT-HK2

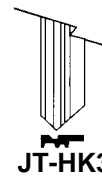

JT-HK3

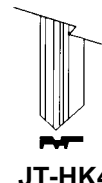

JT-HK4

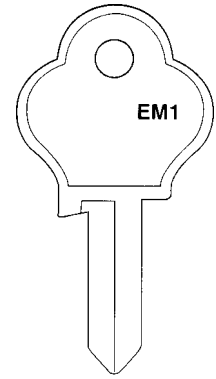

EM1

JT-EM1

HOME DEPOT
STORM DOOR

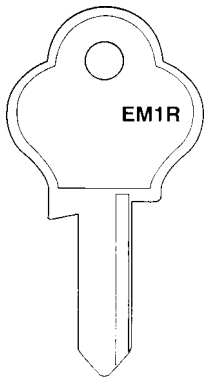

EM1R

JT-EM1R

HOME DEPOT
STORM DOOR

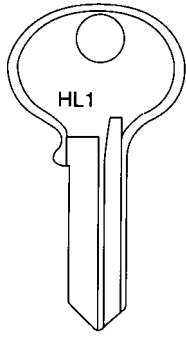

HL1

JT-HL1

HUDSON

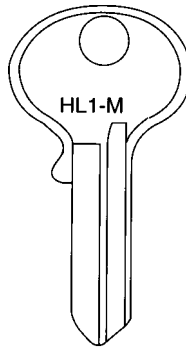

HL1-M

JT-HL1-M

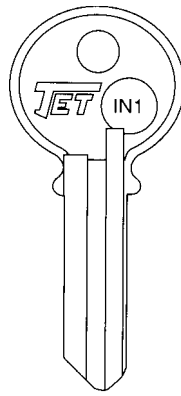

IN1

JT-IN1

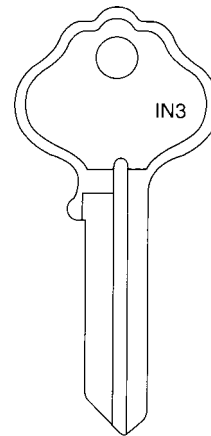

IN3

JT-IN3
JT-IN3-250

(250 Blanks in Bulk Pack)

ILCO

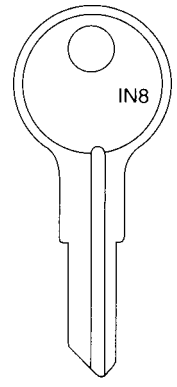

IN8

JT-IN8

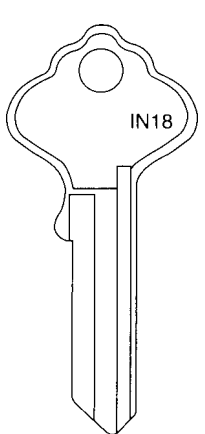

IN18

JT-IN18

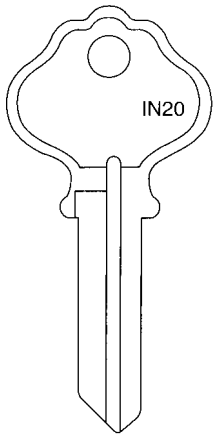

IN20

JT-IN20

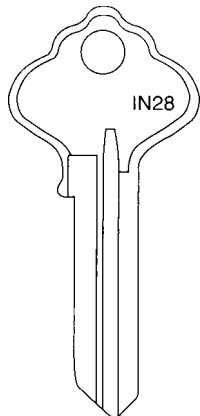

IN28

JT-IN28

ILCO

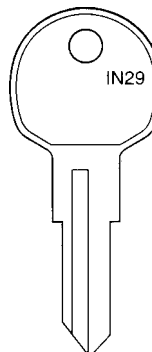

IN29

JT-IN29

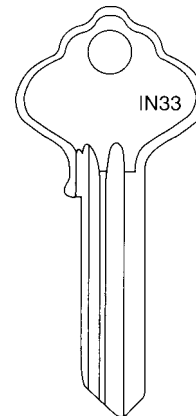

IN33

JT-IN33

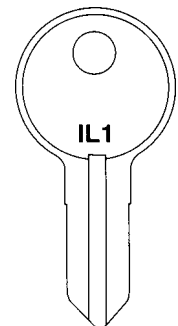

IL1

JT-IL1

ILLINOIS