







# ILCO CYLINDER KEY BLANKS

						
5 pin	1054WD (1)	1054WH	1054WK	1054WL	1054WN	1054WP
6 pin	A1054WD	A1054WH	A1054WK	A1054WL	A1054WN	A1054WP



## FALCON

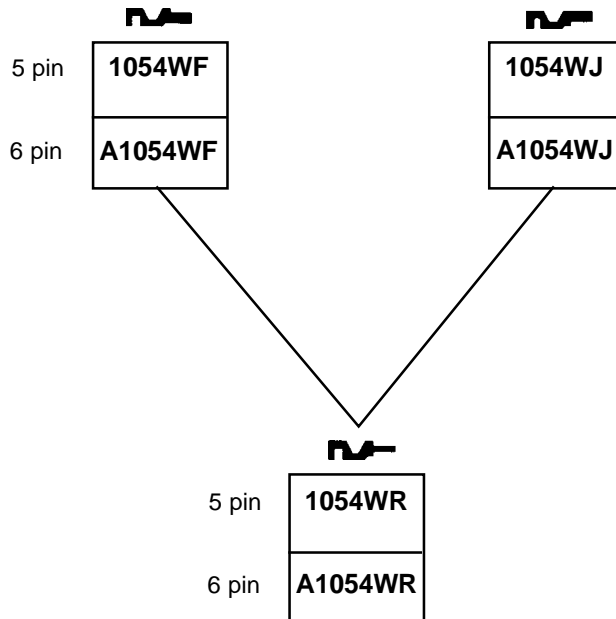
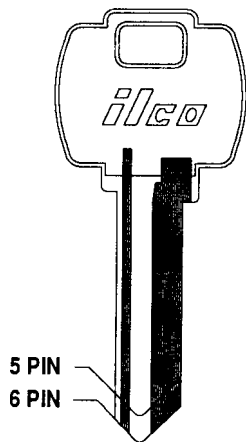
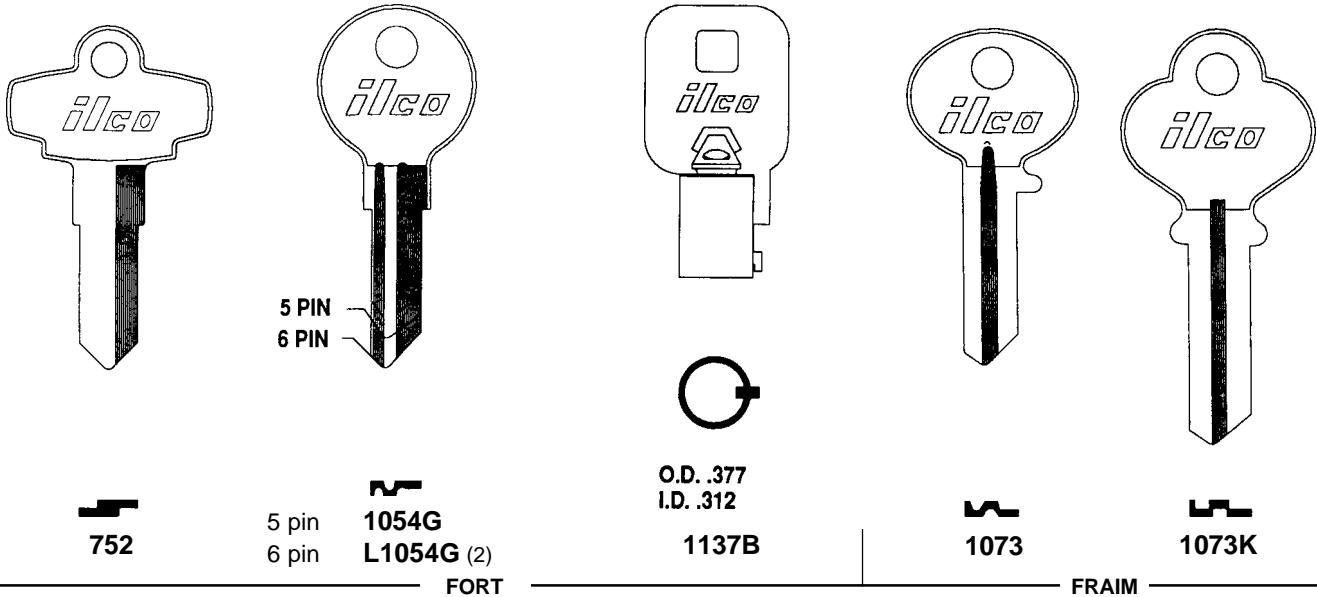

1 - Available in Look Alike, see pages 1070-1072.  
 2 - Available in Taylor Line®, see page 1073.  
 3 - Available in Bin Pack, see page 1074.