

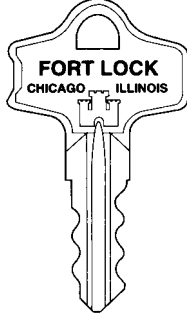

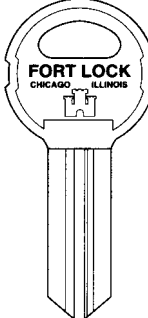

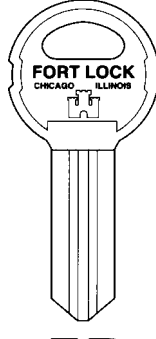

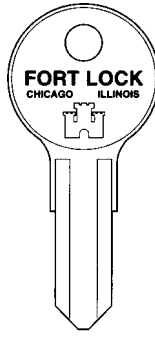











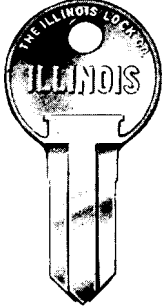

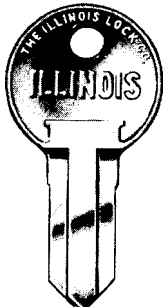
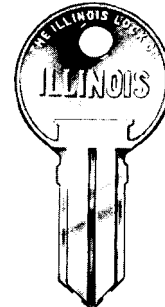





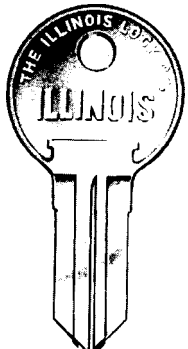
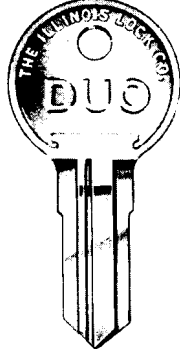

# ORIGINAL CYLINDER KEY BLANKS

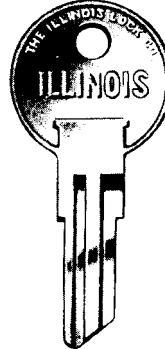
NOTE: Fort blanks may not be actual size.

					
					
<b>K757</b> 6 Disc 5000 Series	<b>K84</b> 10 Disc 16000 Series	<b>K84M</b> 10 Disc 16000 Series Master Key	<b>K60</b> 10 Disc 7000 Series	<b>K752</b> 6 Disc 8000 Series	<b>K775</b> 6 Disc 9000 Series
<b>FORT</b>					

					
					
<b>100</b>	<b>105</b>	<b>110</b>	<b>115</b>	<b>310</b>	<b>220</b>
<b>ILLINOIS</b>					

				
				
<b>210</b>	<b>3027-1-X</b> (X410)	<b>260</b>	<b>360</b>	<b>360M</b>
<b>ILLINOIS</b>				

# ILCO CYLINDER KEY BLANKS

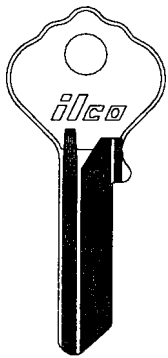

  
X1054JA

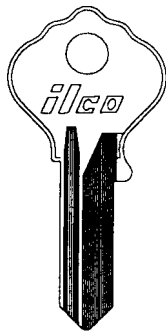

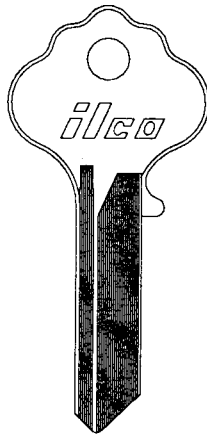

  
X1054JK

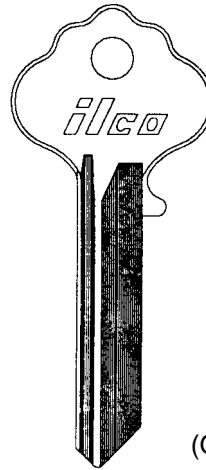

  
X1054K  
(2)



  
X1054KF

  
X1054KR

  
X1054LF

  
X1054LR  
(GOVERNMENT PADLOCKS)

ILCO

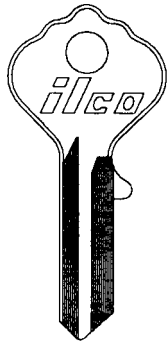

  
X1055GB

  
X1055JK

  
X1055JR  
(GOVERNMENT PADLOCKS)

  
X1055GA

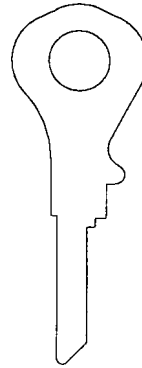

1118

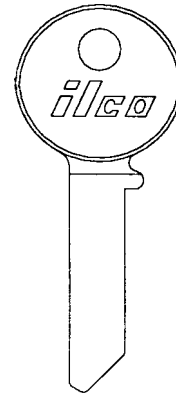



  
1125A

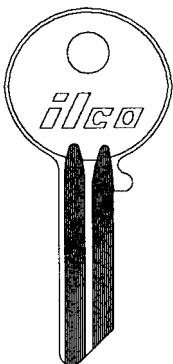

  
1154C

ILCO



  
1154G



  
1154GR



  
1041H

  
1041HM

  
1041P

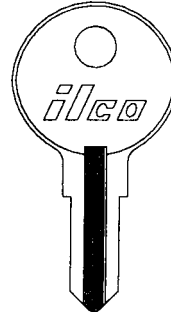

  
1041S

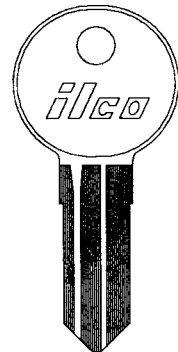

  
1041W

ILCO

ILLINOIS

1 - Available in Look Alike, see pages 1070-1072.  
2 - Available in Taylor Line®, see page 1073.  
3 - Available in Bin Pack, see page 1074.

# ILCO CYLINDER KEY BLANKS

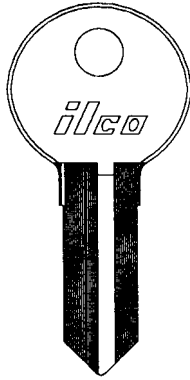
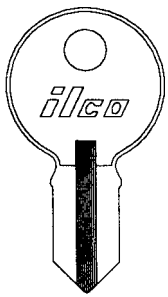

1042B



1042Z

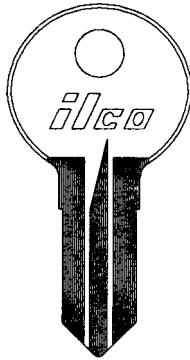

S1042ZM

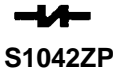

S1042ZP

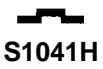
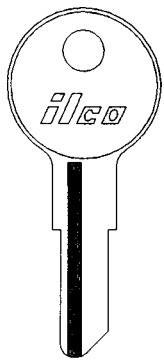
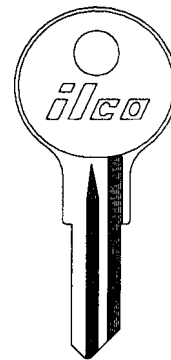

S1041H



1042A



S1042Z



1043ED



1043J

ILLINOIS

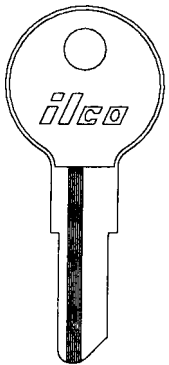

1043C



1043D



1043E

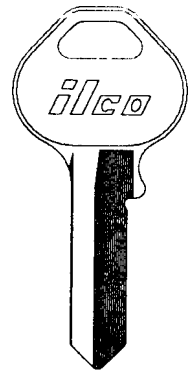
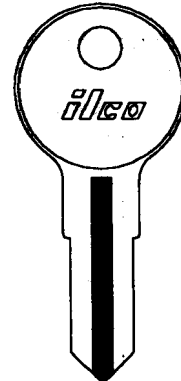
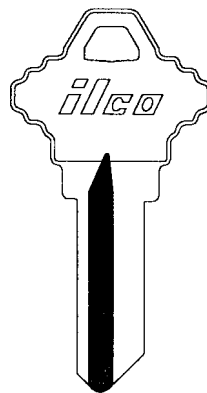
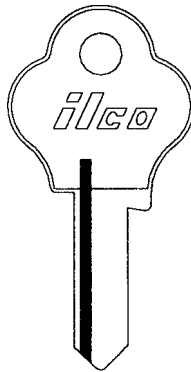

1043B



1043G



1528



1537



1541



1092NTG

ILLINOIS

IMPORT

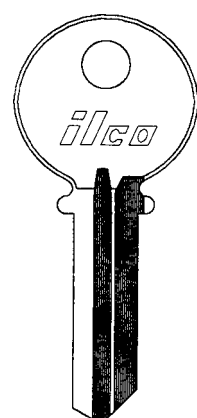
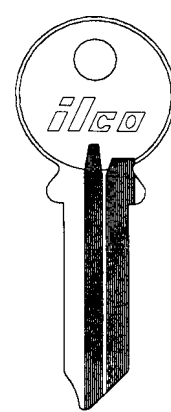
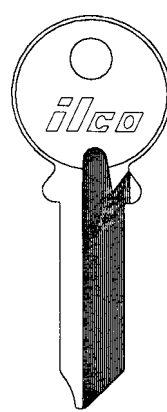
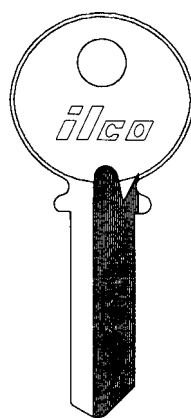
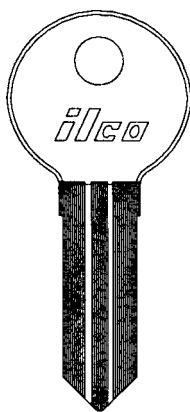
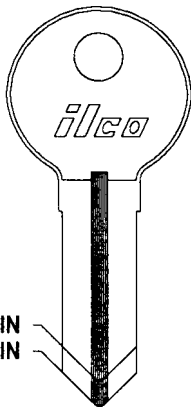

5 PIN  
6 PIN

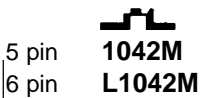

1042M

5 pin  
6 pin

L1042M



L1042B



1079



1079A



1079AB



1079B

G. R. KEY CO.

KEIL

# JET CYLINDER KEY BLANKS

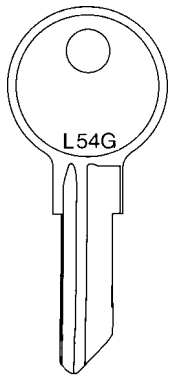

L54G



JT-L54G

FORT

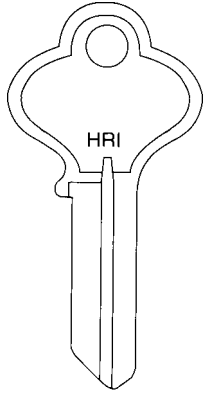

HRI



JT-HR1

HARLOC

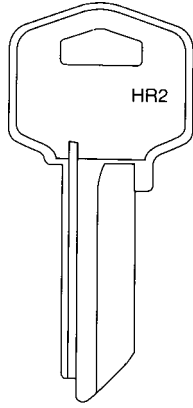

HR2



JT-HR2

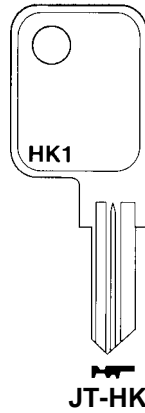

HK1



JT-HK1

HAWORTH

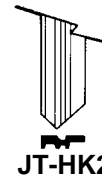

JT-HK2

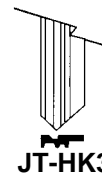

JT-HK3

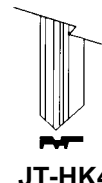

JT-HK4

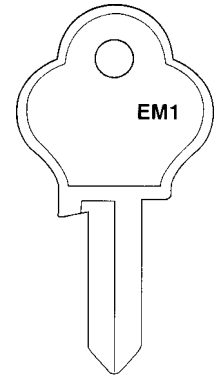

EM1



JT-EM1

HOME DEPOT  
STORM DOOR

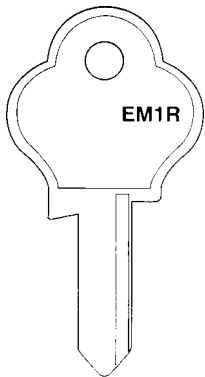

EM1R



JT-EM1R

HOME DEPOT  
STORM DOOR

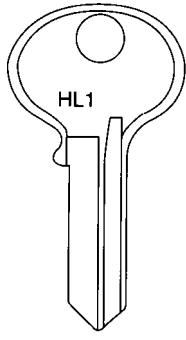

HL1



JT-HL1

HUDSON

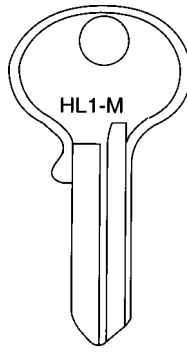

HL1-M



JT-HL1-M

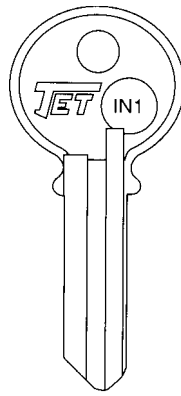

IN1



JT-IN1

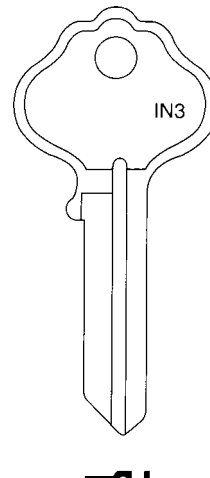

IN3



JT-IN3  
JT-IN3-250

(250 Blanks in Bulk Pack)

ILCO

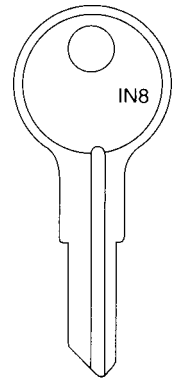

IN8



JT-IN8

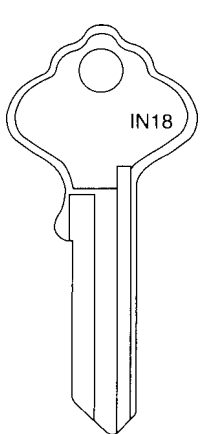

IN18



JT-IN18

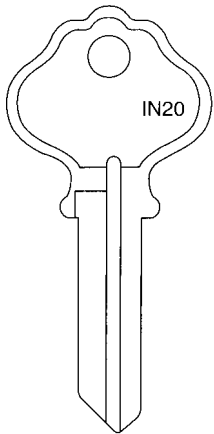

IN20



JT-IN20

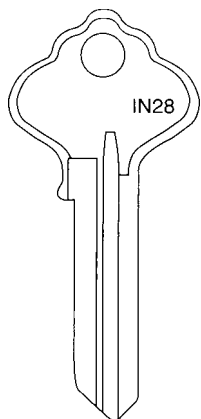

IN28



JT-IN28

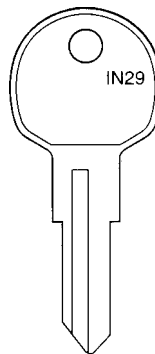

IN29



JT-IN29

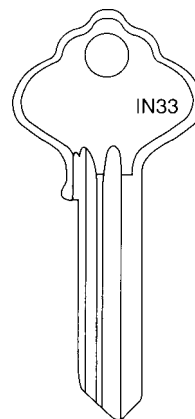

IN33



JT-IN33

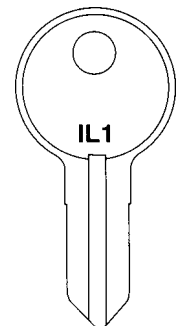

IL1



JT-IL1

ILLINOIS

ILCO