

ZIPF LOCK COMPANY

DOOR & CYLINDER GUARDS

ALUMINUM DOOR SECURITY



STYLE GUARD—K-9/K-21

Made of 12 gauge steel, Style Guard reinforces or repairs aluminum-style doors. 8" long. KD-K-9 for standard 4" jamba and KD-K-21 for 4-1/2" jamba. Designed with a "knock-out" to accommodate either the W&F or the Adams Rite bolt. Baked on enamel-type finish matches nicely for a professional looking job.

Stock No.	Length	Finish
KD-K-9A 626	4"	Aluminum Finish
KD-K-9B 613	4"	Duronotic Finish
KD-K-21A 626	4-1/2"	Aluminum Finish
KD-K-21B 613	4-1/2"	Duronotic Finish

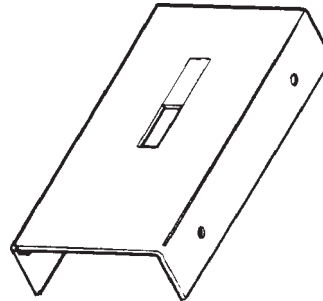

DOUBLE DOOR STYLE GUARD—K-15

Finally a better way to secure a set of double aluminum doors!! 12 gauge steel increases security and can repair doors that have already been attacked. 7-3/4" long, for 1-3/4" doors. Designed with knock out feature to make a W&F into an Adams Rite

Stock No.	Finish
KD-K-15A 626	Aluminum Finish
KD-K-15B 613	Duronotic Finish

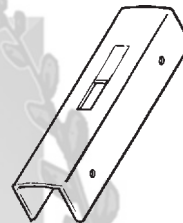

OFFSET STYLE GUARD—K-20

To complete our style guard line we finally have a guard for the offset aluminum door or doors that swing one way with jamb stops. 7" long. This non-handed guard is easy to install and comes with pop rivets and carriage bolts.

Stock No.	Finish
KD-K-20A 626	Aluminum Finish
KD-K-20B 613	Duronotic Finish

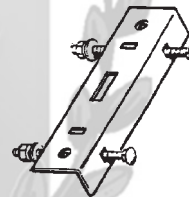

CYLINDER GUARD RING—K-24

Hardened steel, free spinning, tapered cone shaped cylinder guard. Works with both 5 and 6 pin cylinders. Kit includes 6 of each: ring, stainless steel wave washer and spacing collar.

Stock No.	Finish
KD-K-24A 626	Aluminum Finish
KD-K-24B 613	Duronotic Finish

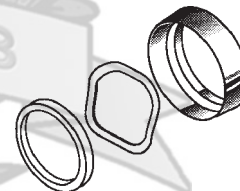

PROTECT-A-LOK—K-12

Finally a product designed to protect locks from impact damage. The Keedex KD-K-12 Protect-A-Lok, made from U.L. approved Lexan plastic, is virtually indestructible by impact. Designed for use in areas where locks may have a chance of getting hit by carts, forklifts or moving vehicles. Can be used with levers, knobs or panic hardware with any size backset. Installs in minutes. Guaranteed for 5 years.

Stock No.	Finish
KD-K-12	Cream Finish
KD-K-12D	Duronotic Finish

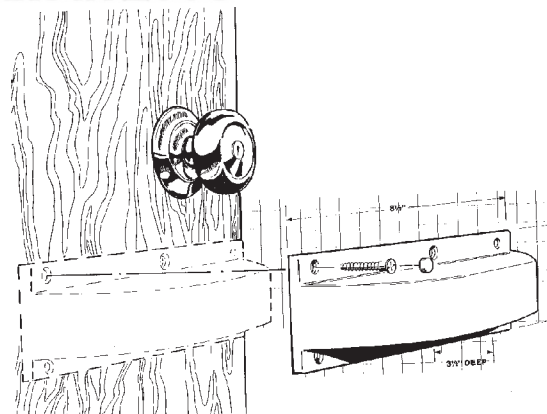

Ideal for Super Markets, Warehouses, Hotels, Hospitals, Restaurants and more.

©ZIPF LOCK COMPANY

308
(PL-24)

"Your warehouse around the corner"

ZIPF LOCK COMPANY

STRIKES



WELDABLE GATE BOXES

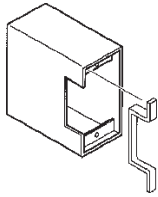

KD-K-BXES1

For installing Trine 005 and Rofu 1106 electric strikes.

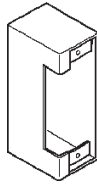

KD-K-BXES2

For installing Rofu 1402, 1702 and 3402 electric strikes. Also Rutherford 7 Series.

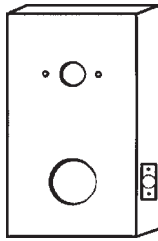

KD-K-BXSIM

For installing Simplex/Unican 1000 Series.



Stock No.

MAG-747-3

Finish

Brass

The ONLY strike to use when installing deadbolts.

- For use with any deadbolt. (Box is 1-5/8" high x 3/4" wide x 1-1/4" deep).
- Standard ASA 1-1/4" x 4-7/8".
- One piece construction.
- Secured by 4—2" long hardened screws.
- 2 screws at bottom of box are offset and installed at a 25° angle allowing screws to enter the stud closer to the center for maximum holding strength. Prevents bolts from being pushed in with punch.
- Box made of heavy 16 gauge steel.

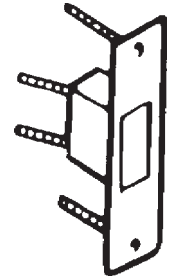

ADJUST-A-STRIKE

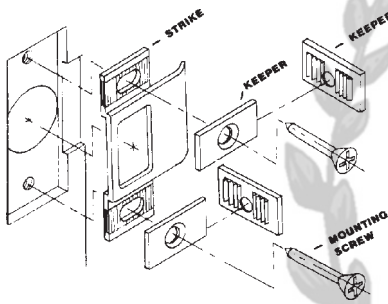

This strike eliminates door rattle, bind on lock bolt, and provides for a snug fit against weather-strip for energy conservation.

Stock No.

MAG-450-B

Finish

Brass

2-3/4" x 1-1/4" Lip Strike

Stock No.

MAG-454-C

Finish

Chrome

4-7/8" x 1-1/4" Lip Strike For Metal Frame

Stock No.

MAG-721-B

Finish

Brass

Large Lip Strike with 2" screws.(4-7/8" x 1-1/4").

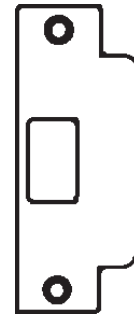

progressive

SECURITY STRIKES

- Heavy gauge steel.
- Brass plated.
- Supplied with 1-1/2" screws.
- Individual poly bagged.



PG-9620

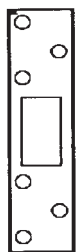

PG-9630

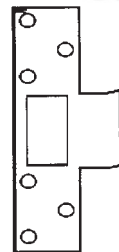

PG-9640

Stock No.

PG-9620

Size

10" x 1-1/4"

PG-9630

5-7/8" x 1-1/8"

PG-9640

5-7/8" x 1-1/8"

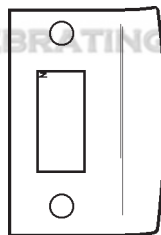

\$PG-73

Passage Strike-Curved Lip Brass Plated

\$-Discontinued. Call for closeout prices

IVES

FLUSH BOLT STRIKE—

Dust Proof Strikes - Threshold Only

- Designed for use with the bottom bolt of the Ives extension flush bolts on non-fire rated openings. For installation in thresholds up to 1/4" thick.
- 3/4" diameter plunger accepts up to 5/8" diameter round bolts or 1/2" square bolts.
- Can be locked in up position by rotating plunger with screwdriver or coin. Eliminates trapping of spiked heels.
- Made from polished wrought brass.
- Dimensions:
Faceplate: 1-3/8" Diameter
Body: 1-61/64" Overall Depth,
Fits Hole 1-1/16" in Dia.

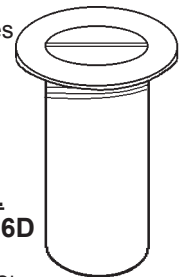

Stock No.

IV-DP3 26D

Finish:

26D Satin Chrome

©ZIPF LOCK COMPANY

515v1
(PL-49)

"Your warehouse around the corner"