

KEY ACCESSORIES



KEY IDENTIFIERS

HOUSE KEY CAP™

Makes a house key easy to find and easy to grip. Unique design inside cap accommodates Schlage, Kwikset and Weiser key heads. Vinyl resists tearing and color fading. Superior material is pliable, but won't break. 7 standard colors: black, blue, green, magenta, purple, red, yellow.

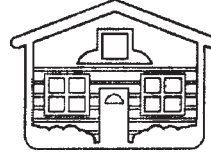

Stock No. **Packaging**
LKC-16200 100/box

KEY RINGS



LARGE KEY RINGS

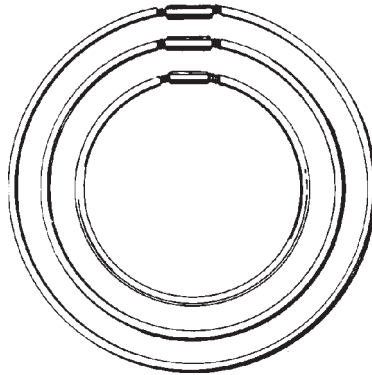

Stock No. **Diameter**
LKR-6 6"
LKR-8 8"

Made of half-hard steel. Threaded fastener, screws either to the left or the right. The 11" ring slips over head easily, for carrying around the neck and will hold about 260 keys.

PULL APART KEY RINGS

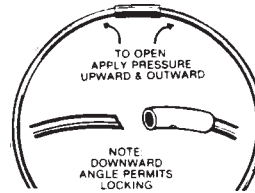

Pull Apart Key Ring is available in three sizes to store a large number of keys. To open and close, pull upward and outward from the top to release tension. Rings are made of 1/8" diameter cadmium plated steel. Sold in boxes of 25 pieces only.

Stock No. **Diameter**
LKC-74300 3-1/2"
LKC-74400 4-1/2"
LKC-74600 6"



LEARN THE TWISTY® SECRET!

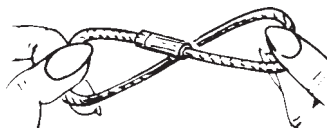
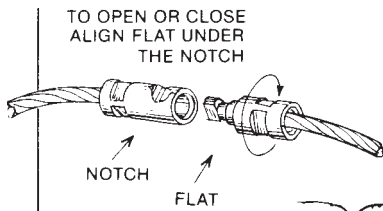

The Twisty® is made of strong, flexible, corrosion-resistant aircraft cable. It features a patented locking connector that is opened and closed by forming a figure 8. The Twisty® is available with a nylon coating in assorted colors or in Stainless Steel in natural as well as Brass plated. An economically priced monofilament is also available in assorted colors.

Stock No.	Material	Pkg.	Length
LKC-81124	Nylon Coated	24/card	4-3/4"
\$LKC-82201	B.P. Stainless	5 cds./box*	5-3/4"
LKC-82901	B.P. Stainless	5 cds./box*	9"
\$LKC-83124	Stainless	24/card	4-3/4"
\$LKC-83201	Stainless	5 cds./box*	5-3/4"
\$LKC-84124	Thin Stainless	24/card	4-3/4"
\$LKC-85124	Monofilament	24/card	4-3/4"

*(1/card) sold by the box only.

\$-Discontinued. Call for closeout prices.

KEY ACCESSORIES



KEY RINGS

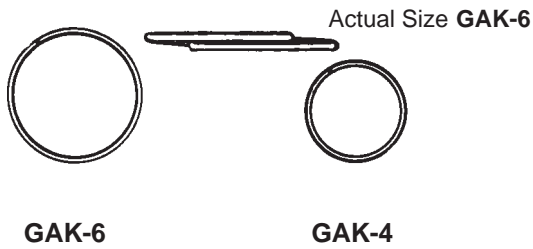

GIVE-AWAY KEY RINGS

<u>Stock No.</u>	<u>Diameter</u>	<u>Quantity</u>	<u>Gauge</u>
GAK-4	3/4"	1000	.0475
GAK-6	1"	1000	.0475

Manufactured from hardened spring steel wire and bright zinc plated to resist tarnishing.

These rings are so inexpensive that they can be given away with duplicate keys.



FLX-O-LOC® is made of strong, flexible, corrosion resistant aircraft cable with a patented ball-knob and socket that locks and unlocks easily, yet is secure and strong. Available in nylon coated steel. 5" length. Assorted colors.

Stock No. **Packaging**
LKC-71101 5 cards/box (1/card)*
LKC-71124 24/card
 *sold by the box only

TANG KEY RING



Tang Key Ring — The inside tang makes it quick and easy to put keys on this ring. The ring is a bright nickel plated spring wire and measures 1" in diameter.

Stock No. **Packaging**
\$LKC-75200 100/box

SPRING SLEEVE KEY RING

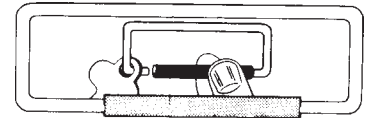

Spring Sleeve Key Ring — An inexpensive, durable key ring with a bright nickel finish and functional styling. Pull to open — release to close. Measures 3/4" X 2".

Stock No. **Packaging**
\$LKC-70424 24/card
\$LKC-70400 100/box

-\$-Discontinued. Call for closeout prices.

3 WAY PULL-A-PART KEY RING

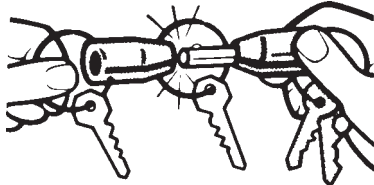

This practical key holder lets you store lots of keys on a central holder. You can organize them by group; e.g. home, work, auto, and take only those you need. Supplied with three 7/8" key rings. Steel body and red and blue anodized aluminum ends.

Stock No. **Packaging**
LKC-71712 12/card

QUICK RELEASE (Pull Apart) Key Ring

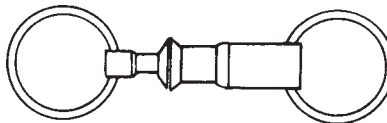

This is the ideal key ring for those who must leave their car keys with others. By pushing the small button the keys are separated without removing the key from the ring. Supplied in nickel finish with two 7/8" split key rings. Overall length is 3".

Stock No. **Packaging**
LKC-70712 12/card

KEY ACCESSORIES



KEY RINGS

SPLIT KEY RINGS Heavy-Duty Tempered Steel Nickel Plated



Lucky Line's most popular split key ring, made of heavy-duty nickel plated tempered steel.

Stock No.	Size	Pkg.
LKC-76000	1/2"	100/box
LKC-76100	5/8"	100/box
LKC-76200	3/4"	100/box
LKC-76300	7/8"	100/box
LKC-76400	1"	100/box
LKC-76500	1-1/8"	100/box
LKC-76600	1-1/4"	100/box
LKC-76800	1-1/2"	50/box
LKC-77000	2"	50/box
LKC-79100	3"	25/box

COLORED SPLIT RINGS Tempered Steel Rings - Durable Coating 6 Colors Available

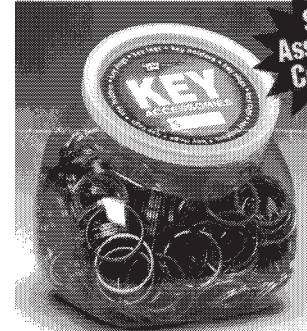
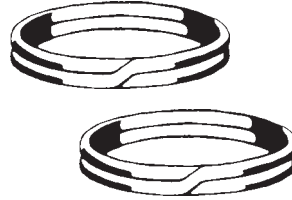

Colored Split Rings Assortment (200/jar)—

Stock No.	Description
\$LKC-79425	Assortment

1" Colored Split Rings (25 rings per bag)—

Stock No.	Description
\$LKC-79430	Blue
\$LKC-79440	Apple Green
\$LKC-79446	Neon Green
\$LKC-79465	Purple
\$LKC-79466	Neon Pink
\$LKC-79470	Red

\$-Discontinued. Call for closeout prices.

SPLIT KEY RING DISPLAY

The best way to sell key rings! 365 of our heavy-duty, nickel plated key rings in 11 popular sizes from 1/2" to 2". Display for counter or wall measures 6" X 6" X 13".

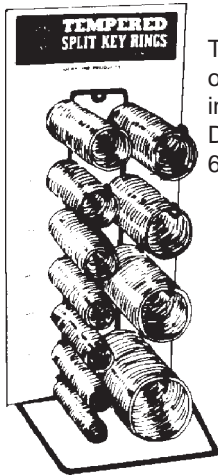

Stock No. LKC-36500 contains:

Qty.	Size	Qty.	Size
40	1/2"	30	1-1/4"
40	5/8"	30	1-3/8"
40	3/4"	25	1-1/2"
40	7/8"	25	1-3/4"
40	1"	25	2"
30	1-1/8"		

KEY ACCESSORIES

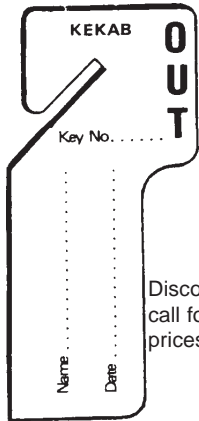

OT-100
OUT TAGS
100 per pack
Sold by the pack

Discontinued—
call for closeout
prices

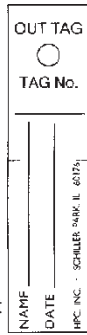

OT-2T
OUT TAGS
20 per pack
Sold by the pack
For 2-tag Kekabs

KEY TAGS

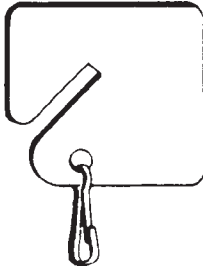

PLT-1
PLASTIC
PLAIN TAGS
100 per pack
Sold by the pack

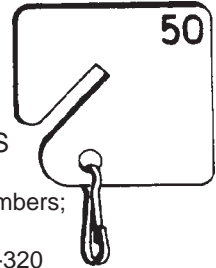

NT-1
NUMBERED TAGS
with Snap Hooks
Packed in series of 20 numbers;
i.e. 1-20, 21-40, etc.
We stock 1-20 thru 301-320

SPECIFY numbers when ordering.
Ex: **NT-1 (41-60)**

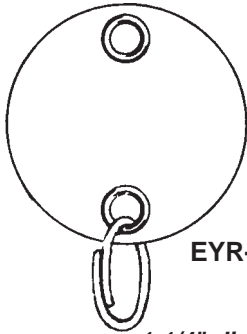

EYR-5
1-1/4" diameter—
Stock No. Description
EYR-5 with 5/8" rings

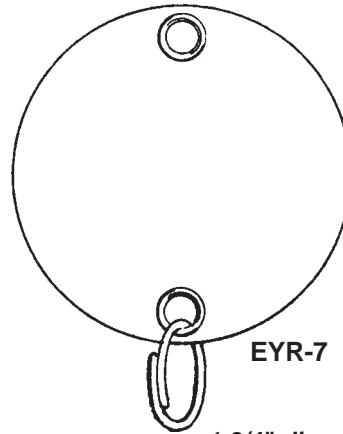

EYR-7
1-3/4" diameter—
Stock No. Description
EYR-7 with 5/8" rings

Packed 100 per box. Tags are white in color except OT-100 are yellow.



Paper key tags (white)
with metal rims.

Stock No.	Diameter
34MR	1-9/16"
35MR	1-7/8"
36MR	2-1/4"

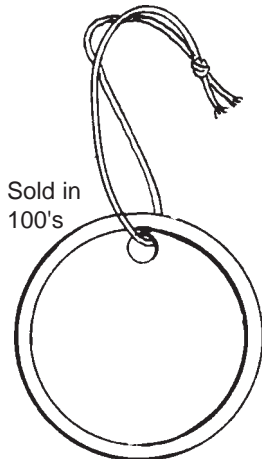

Sold in
100's



Stock No.	Diameter
LKC-27000	15/16"
LKC-27200	1-1/4"

High powered sales in a mini-
amount of space. Geared
for high impulse sales! We've
taken one of our most popular-
selling products and packaged
it in an eye-catching transparent
counter top display. The dis-
play measures approximately
3-1/2" X 4".

Discontinued. Call for closeout price

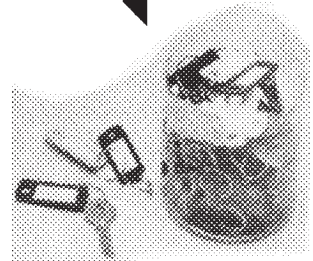

Stock No. Description
\$ES-BKI-72 Key Tag Identifiers
The vinyl tag identifiers are one of the most popular items. 8
colors, packed 72 pieces per eye-catching display.

©ZIPF LOCK COMPANY

KEY ACCESSORIES



KEY TAGS

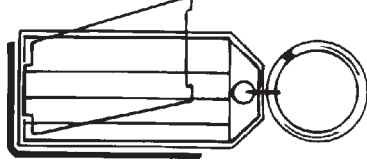

A tough polypropylene key tag (1-1/8" X 2-1/4") with an easy open/close flap for the paper insert. No need to remove the key ring to remove the insert! Comes assembled with a jump ring and 7/8" tempered split key ring and is supplied in 8 transparent colors.

Stock No. **Packaging**
LKC-60502 5 cards/box-2/card*
LKC-60500 100/box

*sold by the box only

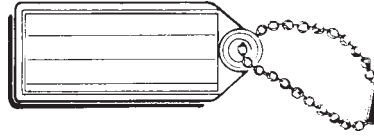

A compact, transparent tag (15/16" X 2-1/4") with a heavy-duty 4-1/2" ball chain that is ideal for keys or luggage. The tag is supplied in 8 colors with a paper insert for writing identifying information.

Stock No. **Packaging**
LKC-10124 24/card
LKC-10100 100/box

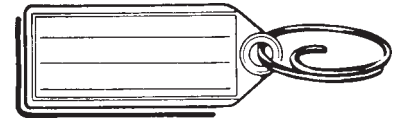

A compact tag (15/16" X 2-1/4") with an easy operating 1" tang ring that is designed to save fingernails! Adding or taking keys off this ring is as quick as 1-2-3. Supplied in 8 transparent colors with a paper insert for writing identifying information.

Stock No. **Packaging**
LKC-12324 24/card
LKC-12300 100/box

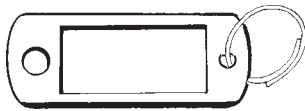

Econo Tag is made of ultra-flexible sturdy polyethelene. The small slot in the back of the tag allows easy removal of the paper insert while a clear plastic insert protects the pager from wear and tear. Tag can be hung on a hook, measures 7/8" x 2". Comes with a 3/4" overlapping ring. Assortment comes with 6 colors: black, blue, green, purple, red and yellow.

Stock No. **Packaging**
LKC-16900 200/box



Tough propionate resist breakage. Paper insert slides out for easy writing. 7/8" nickel plated tempered steel split key ring. Available in clear only. Tag measures: 1-1/8" x 2-1/4".

Stock No. **Packaging**
\$LKC-20402 5 cards/box-2/card*
LKC-20400 100/box

*sold by the box only

\$-Discontinued. Call for closeout prices.

KEY TAG RACKS

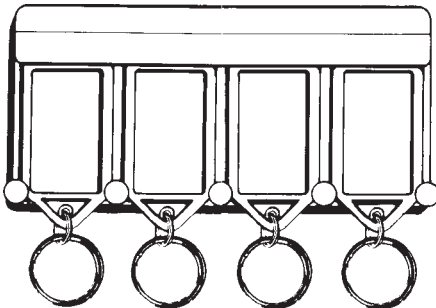

Stock No.
LKC-60540

This 4 key Tag Rack comes with pressure sensitive pads for easy mounting to any surface. Size: 5" X 2-1/2" X 1/2".

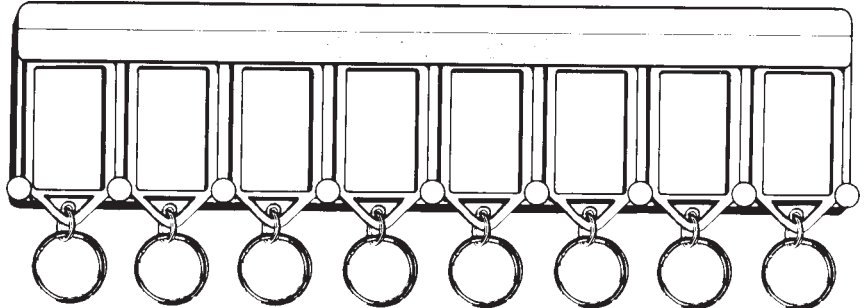

Stock No.
LKC-60580

This 8 Key Tag Rack comes with two screws for easy mounting. It can also be mounted with pressure sensitive tape. Size: 10" X 2-1/2" X 1/2".

©ZIPF LOCK COMPANY

KEY ACCESSORIES



SOLID BRASS KEY TAGS

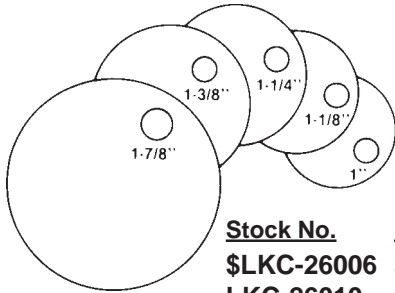

These sturdy round Brass Key Tags feature one hole and are ideally suited for stamping. Available in six popular sizes, each .040" thick. Packaged 100/box.

<u>Stock No.</u>	<u>Diameter</u>	
\$LKC-26006	3/4"	-\$-Discontinued. Call for closeout prices.
LKC-26010	1"	
LKC-26011	1-1/8"	
LKC-26012	1-1/4"	
LKC-26013	1-3/8"	
LKC-26017	1-7/8"	

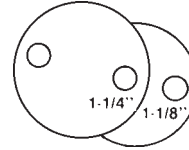

These sturdy round Brass Key Tags feature two holes and are ideally suited for stamping. Available in two popular sizes, each .040" thick. Packaged 100/box.

<u>Stock No.</u>	<u>Diameter</u>	
\$LKC-26021	1-1/8"	-\$-Discontinued. Call for closeout prices.
\$LKC-26022	1-1/4"	



MISCELLANEOUS KEY ACCESSORIES

BALL CHAIN KEY CHAINS



This pre-cut 4-1/2" nickel plated steel ball chain is corrosion resistant and comes with connector attached.

<u>Stock No.</u>	<u>Packaging</u>
\$LKC-31424	24/card

-\$-Discontinued. Call for closeout prices.

BALL CHAIN SPOOLS & CONNECTORS

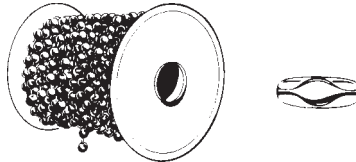

Make any length key chain or neck chain you require. Simply cut the desired length and attach the companion connectors. Available in nickel plated steel. Chain is 1/8" in diameter.

<u>Stock No.</u>	<u>Packaging</u>
Chain—	
LKC-31700	100 ft. spool
Connectors—(coupling)	
LKC-31900	100 per pkg.
Precut chain with connectors—	
6" increments	
\$LKC-31500	100/pkg.

-\$-Discontinued. Call for closeout prices.

KEY LIGHT

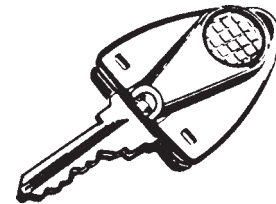

An ideal accessory for anyone who needs to find a key and light up the key hole in the dark. Assorted colors per box: black, purple, blue, red and green. Key blank not included.

<u>Stock No.</u>	<u>Packaging</u>
LKC-90801	5 cards/box (1/card). Sold by the box only.

KEY ACCESSORIES



MISCELLANEOUS KEY ACCESSORIES

ACRYLIC PHOTO HOLDER

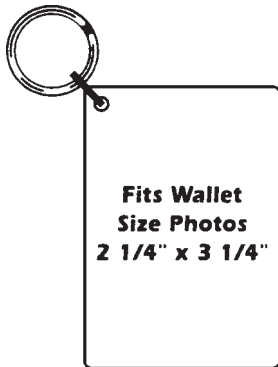

Holds wallet and school photos securely, allows for easy replacement. Clear acrylic resists scratching. Made from one piece of tough acrylic with 1-1/8" nickel plated tempered steel split key ring and 1/2" overlapping ring. Photo holder measures: 2-3/8" x 3-1/4".

Stock No. **Packaging**
\$LKC-20501 5 cards/box (1/card)

\$-Discontinued. Call for closeout prices.

WRIST COIL W/WHISTLE



Superior quality coil always springs back; never loses its shape. Durable plastic whistle is securely attached with 7/8" nickel plated tempered steel split key ring. Fits comfortably over wrist for work, exercise, sports. Color coordinated combinations available in black, dark blue, red. Coil measures 2" in diameter, stretches to more than 12" in diameter.

Stock No. **Packaging**
\$LKC-42301 5 cards/box (1/card)
\$-Discontinued. Call for closeout prices.

PLASTIC WHISTLE



Lightweight, durable whistle fits perfectly on lanyard, plastic key clip or wrist coil. Made of tough molded plastic, comes with 1" nickel plated tempered steel split key ring. Available in black, dark blue, red. Without split ring, whistle measures 2"

Stock No. **Packaging**
LKC-42101 5 cards/box (1/card)

LANYARD W/WHISTLE



Popular with coaches and children. Color coordinated lanyard and whistle are available in black, dark blue, red. Red whistle has white lanyard.

Stock No. **Packaging**
LKC-42201 5 cards/box (1/card)

QUICKOIN COIN HOLDER

by QUIKEY

- Squeeze to open
- Never loose a coin
- Heavy-duty key chain
- Made in U.S.A.

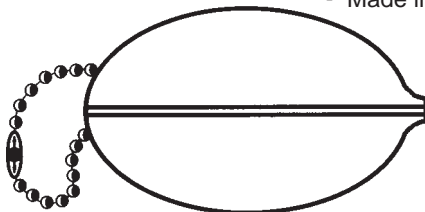

Stock No. **Packaging**
QK-12 12/display card

Opens easily—closes tight. Made of new soft duralastic. 1 dozen assorted red, blue and green on a colorful display card.

©ZIPF LOCK COMPANY

KEY CABINETS

Single Tag



HPC's single-tag key security control system is designed to control and provide security for 8 to 730 keys. KEKABS are ideal for home, store, or office use, where centralized or departmental key control is desired. They are designed to be mounted on a wall, near a desk, or a workstation.

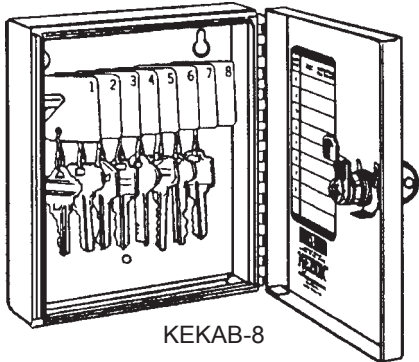

KEKAB-8

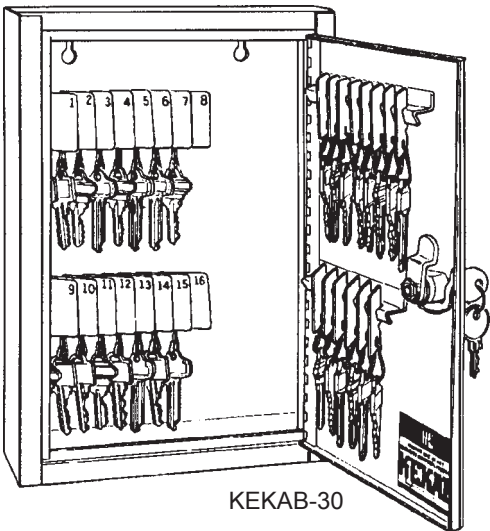

KEKAB-30

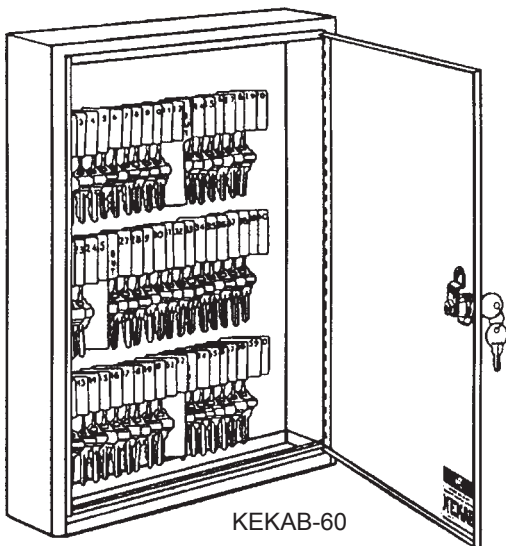

KEKAB-60

Each HPC KEKAB security control system includes:

- **White Plastic Key Tags** with bright nickel plated snap-hooks which can hold multiple keys on each snap-hook. The tags are numbered for easy identification.
- **Durable Steel Key Racks** that are slotted to store key tags uniformly for immediate identification.
- **"Out Key" Control Tags** that are made of yellow paper. They are used for accountability (to record information on loaned keys).
- **Lock Location Data** which consists of an erasable lock location chart as part of the KEKAB-8 and numbered key control booklets with all other KEKABS.
- **Unique Powder Coat Textured Painting Process** which provides an attractive and very durable finish. The neutral sand color allows them to be hung anywhere.
- **Heavy Gauge Steel Construction** with piano hinged doors and key panels provides a sturdy location to secure your keys.

Most Single-tag KEKABS are equipped with a 5 wafer tumbler lock with two keys. **KEKABS denoted with an asterisk (*) are equipped with a high security 7 pin tubular lock with popout T-handle.** All KEKABS can be keyed-alike, master-keyed or furnished with a combination lock or dual control locks at an additional charge (factory order). The "X" at the end of the stock number denotes that the cabinet is expandable.

<u>Stock No.</u>	<u>Capacity</u>	<u>Dimensions</u>
KEKAB-8	8 keys	6-5/8" x 5-3/4" x 2"
KEKAB-30	30 keys	12" x 8" x 2-1/2"
KEKAB-40	40 keys	12" x 8" x 2-1/2"
KEKAB-60	60 keys	17" x 13" x 3-1/4"
KEKAB-80	80 keys	17" x 13" x 3-1/4"
KEKAB-120	120 keys	17" x 13" x 3-1/4"
KEKAB-160X	160 keys	20" x 16-1/2" x 5"
KEKAB-240	240 keys	20" x 16-1/2" x 5"
* KEKAB-260X	260 keys	25-1/4" x 18" x 5-1/2"
KEKAB-330	330 keys	20" x 16-1/2" x 5"
* KEKAB-500	500 keys	25-1/4" x 18" x 5-1/2"
* KEKAB-730	730 keys	25-1/4" x 18" x 7"

EXPANSION LEAVES-When your key control needs grow, so can your system. Leaves are easy to install and come with all necessary hardware, numbered tags (to increase capacity number) and control chart.

<u>Stock No.</u>	<u>For Kekab:</u>	<u>Increase From</u>	
KEKAB-DA	DL95X, KK95X	95 to 265 Keys	<i>Special Order</i>
KEKAB-A	KEKAB-160X	160 to 330 Keys	
KEKAB-B	KEKAB-260X	260 to 500 Keys	

©ZIPF LOCK COMPANY

KEY CABINETS

Two-Tag



HPC's two-tag security key control system is designed to control and provide security for 30 to 500 keys. The two-tag system enables your to loan a key, while keeping a copy in the cabinet for emergency use. The two-tag KEKAB is designed to be mounted on a wall, near a desk, or a workstation.

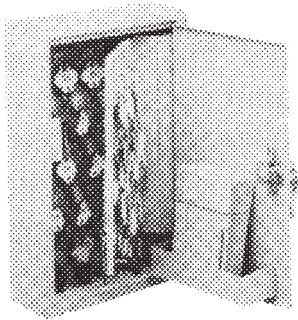

KEKAB-T30

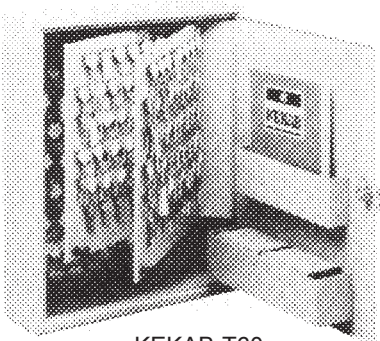

KEKAB-T60

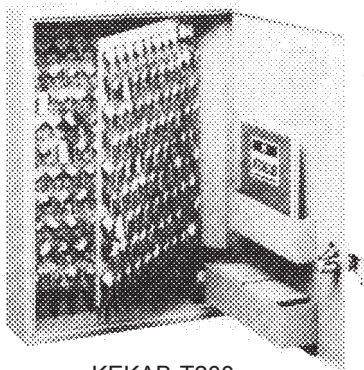

KEKAB-T200

Each HPC KEKAB II security control system includes:

- **Red Plastic Octagonal Permanent Key Tags** have self-locking key holder. This key tag is designed to hold the original key and remain in the KEKAB. The tags are numbered for easy identification.
- **White Plastic Cloverleaf Loaner Key Tags** are used to hold duplicates of the permanent key. The tags are numbered for easy identification.
- **Key Organization Sleeves** are for the collection of keys. These envelopes are pre-printed with room for pertinent information.
- **Key Receipt Slips** are designed to keep a record of keys loaned out. Personnel must fill out slips in order to obtain a key. The slip is then hung on the appropriate hook in the KEKAB in place of the loaned key.
- **Brass Receipt Holder** for optional use of holding key receipt slip on hook. (Complies with governmental regulations.)
- **Cross Reference Binder** contains three referencing methods for a detailed record of all keys. Includes complete key loan record, cross reference sheets and detailed instruction sheet.
- **Unique Powder Coat Textured Painting Process** provides an attractive and very durable finish on all KEKAB units. The neutral sand color allows them to be hung anywhere.
- **Heavy Gauge Steel Construction** with piano hinged doors and key panels provides a sturdy location to secure your keys.

All KEKAB II cabinets listed below are equipped with a 5 wafer tumbler cam lock and two keys. All KEKABS can be keyed-alike, master-keyed or furnished with a combination lock or dual control locks at an additional charge (factory order). The "X" at the end of the stock number denotes that the cabinet is expandable. **KEKABS denoted with an asterisk (*) are equipped with a high security 7 pin tubular lock with pop-out T-handle.**

<u>Stock No.</u>	<u>Capacity</u>	<u>Dimensions</u>
\$KEKAB-T30	30 keys	12" x 8" x 2-1/2"
\$KEKAB-T40X	40 keys	17" x 13" x 3-1/4"
KEKAB-T60	60 keys	17" x 13" x 3-1/4"
KEKAB-T80X	80 keys	20" x 16-1/2" x 5"
* \$KEKAB-T100X	100 keys	30" x 18" x 5-1/2"
\$KEKAB-T120X	120 keys	20" x 16-1/2" x 5"
\$KEKAB-T160X	160 keys	20" x 16-1/2" x 5"
\$KEKAB-T200	200 keys	20" x 16-1/2" x 5"
\$KEKAB-T240	240 keys	20" x 16-1/2" x 5"
* \$KEKAB-T300X	300 keys	30" x 18" x 5-1/2"
* \$KEKAB-T400	400 keys	30" x 18" x 5-1/2"
* \$KEKAB-T500	500 keys	30" x 18" x 5-1/2"

Keycabs marked with \$ are special order. Some in stock at close-out prices.

EXPANSION LEAVES-When your key control needs grow, so can your system. Leaves are easy to install and come with all necessary hardware, numbered tags (to increase capacity number) and control charts. **FACTORY ORDER.**

KEY CABINETS



SLIMKABS™

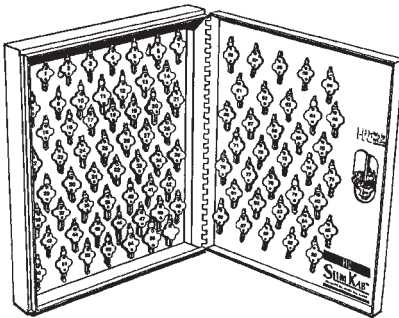

SlimKab™ — The SlimKab line is an economical line of key control cabinets. They are available in two expandable sizes (SK-55X is special order). The cabinets are made of 22 gauge steel and come equipped with a five wafer cam lock. They are painted in a neutral sand color. The hooks for the tags are a single prong style (made for standard rings). This enables you to use any key ring in the SlimKabs. The "X" at the end of a stock number denotes that the cabinet is expandable. The expansion leaves are factory order.

<u>Stock No.</u>	<u>Capacity</u>	<u>Dimensions</u>
SK-15X	15 keys	10-1/2" x 6" x 1-1/2"

MEDI-KAB™



\$MEDI-KAB 3
12" x 8" x 2-1/2"

\$-Discontinued. Call for closeout prices.

HPC's Medi-Kab offers the most secure location for medicine and pharmaceuticals. The welded construction is from the finest heavy gauge steel. The Medi-Kab also features a rugged piano hinged door for security purposes. All Medi-Kabs use a cam lock. These locks can be keyed alike or keyed differently to meet virtually any security requirement. Also available in Dual Control Locks (factory order)

The powder coat textured painting process is in a neutral sand color finish that is suitable for any decore, office or home. At the office, the MEDI-KAB is designed to be mounted on a wall, near a desk, or a work station. In the home the MEDI-KAB is designed to be used in the kitchen, bathroom or closet.

FIRE EXTINGUISHER CABINETS

HPC's Fire Extinguisher Cabinets are available in four sizes to fit the most popular sizes of fire extinguishers on the market. They are made of heavy gauge steel and painted in glossy white. The units are perfect for use in offices, warehouses, and hospitals. In the event that the fire extinguisher is needed, a hammer (that is attached to the top of the unit) is used to break the scored plexiglass on the front of the cabinet.

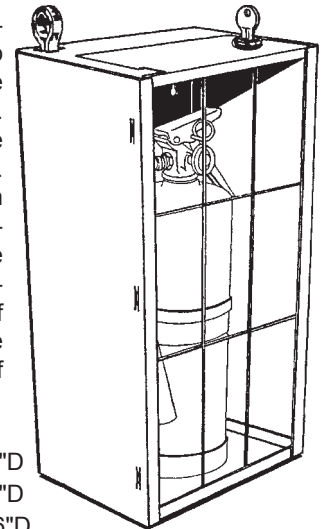

Discontinued-call for closeout prices

<u>Stock No.</u>	<u>Dimensions</u>
FXC-18	18"H x 8"W x 6"D
FXC-22	22"H x 8"W x 6"D
FXC-24	24"H x 10"W x 6"D
FXC-30	30"H x 12"W x 9"D

We do not sell fire extinguishers.

EMERGENCY KEY BOX

511 KA Keyed Alike
511 Glass Plexiglass Only
6-5/8"H x 5-3/4"W x 2"D
These boxes are designed to secure a restricted key at the immediate location. The bright red steel box has a key-locking hinged door with a plexiglass window. When an emergency arises and access to a specific key is necessary, break plexiglass with the attached hammer.

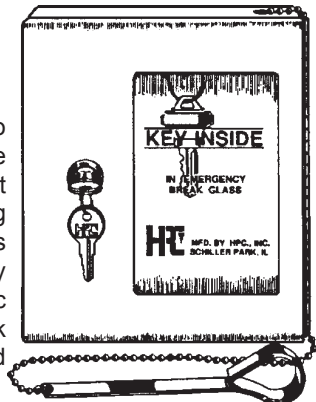

KEY CABINETS

KEKAB ACCESSORY TAGS

KEKAB Accessory Tags fits all KEKABS, Key boards, Key Racks, Carrying and Drawer KEKABS. The key tags are available numbered or plain.

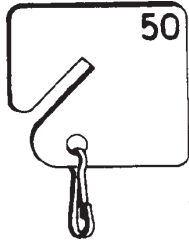

NT-1
NUMBERED TAGS
 with Snap Hooks
 Packed in series of 20 numbers;
 i.e., 1-20, 21-40, etc.
 We stock 1-20 thru 301-320.

SPECIFY numbers when ordering.

Ex: **NT-1 (41-60)**

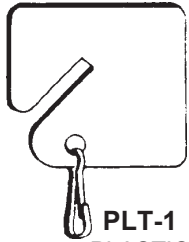

PLT-1
PLASTIC
PLAIN TAGS
 100 per box
 Sold by the box.

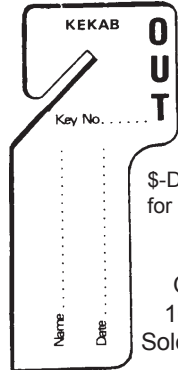

Yellow Paper

-\$-Discontinued-call for closeout prices

\$OT-100
OUT TAGS
 100 per pack
 Sold by the pack.



RECESSED CABINET FRAME

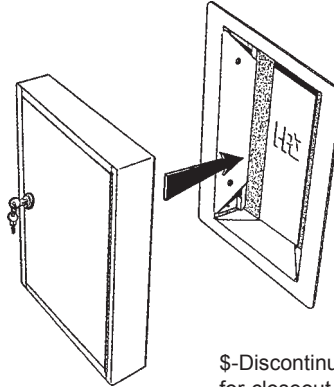

-\$-Discontinued-call for closeout prices

\$RCF-6

The Recessed Cabinet Frame (RCF-6) can be installed almost anywhere. It is for use with KEKAB-60, KEKAK-80, KEKAB-120, KEKAB-T40, KEKAB-T60, MEDI-KAB 6 and MEDI-KAB 6DC (units need to be drilled, using the frame as a template). The Recessed Cabinet Frame allows for the key control unit to be completely flush with the wall. The unit is made of heavy-gauge steel and painted in a neutral sand color. It is extremely easy to install, and the overlap lip of the frame allows for a margin of error when cutting. **KEY CABINETS SOLD SEPARATELY.**

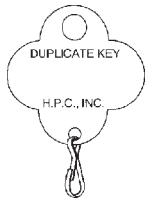

\$PLT-2T
PLAIN UN-NUMBERED
LOANER TAGS
 100 per box
 Sold by the box.

TWO-TAG KEKAB ACCESSORIES

-\$-Discontinued-call for closeout prices

\$OT-2T
OUT TAGS
 20 per envelope
 Sold by the envelope.

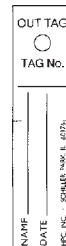

OVER DOOR KEY KEEPER™

No more lost keys or lockouts! Secure one key or several in the keeper. The box is placed over the top edge of the door. When the door is closed, the top mounting screws are hidden. It has a sturdy piano hinged door and is made of heavy gauge steel and has a glossy white finish. Box is furnished with a 7 pin tubular key lock and one key. Box Size: 3-1/4"H x 2-1/2"W x 2"D.

<u>Stock No.</u>	<u>Keyed Alike No.</u>
KEP-12-96	3396
\$KEP-12-97	3397

Furnished with one key per box.
-\$-Discontinued. Call for closeout prices.

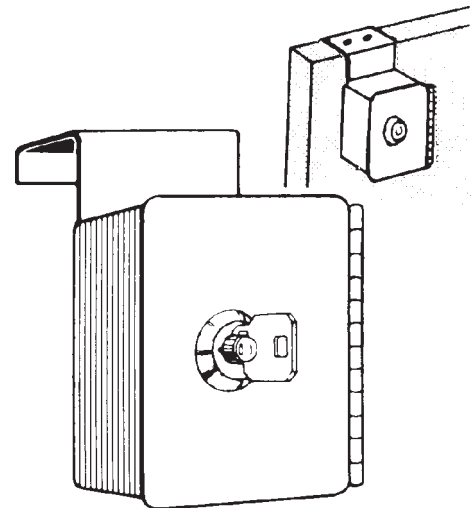

KEY CABINETS

HPC



MOUNT
UNDER
HOOD

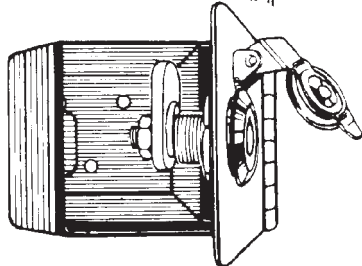
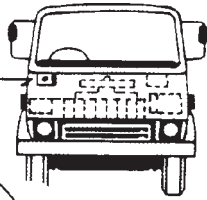

TRUCK KEY KEEPER™

For trucking firms and commercial truck fleets.

This key keeper is perfect for trucking firms and commercial truck fleets. The box made of heavy gauge steel, with a charcoal grey baked enamel finish.

It keeps keys secure within a truck, as well as eliminate loss of ignition keys for large fleets. HPC's Key Keeper is like a small bank vault. It mounts under the hood, onto an inside fender or body wall, with the three included sheet metal screws. Each keeper comes complete with a 7 pin tubular lock with dust cover and one key. Box Size: 3-1/2"H x 3-1/4"W x 1-1/2"D.

Stock No. **Keyed Alike No.**
KEP-16-95 3395
 Furnished with one key.

ilco

Single tag key cabinets are designed to secure and provide a secure centralized key control location for home, office, store and commercial locations. Key Cabinets are available in the most popular sizes, 10, 30, 60, 120 and 200 key capacities.

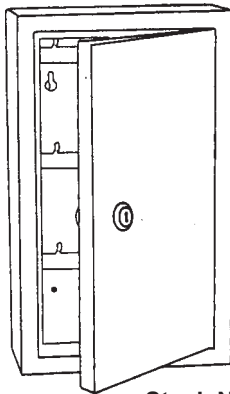

- Wall mounted design.
- Locking cabinets features ILCO® cam lock with two keys.
- Heavy gauge steel construction with welded, round corners.
- Sturdy continuous door hinge.
- Durable welded slotted steel key racks.
- Durable powder coat, neutral sand beige texture finish.
- White plastic, numbered single set key tags with nickel plated snap-hooks included (additional tags sold separately).
- Includes key control log.
- Each cabinet is packed in a consumer appealing box suitable for retail display. (English, Spanish and French)

Stock No.	Capacity	Width	Depth	Height	LBS
IL-KEY CABINET 10	10	7.1	2.0	6.7	2.43
IL-KEY CABINET 30	30	7.1	2.0	11.8	4.19
IL-KEY CABINET 60	60	13.4	3.9	19.3	12.13
IL-KEY CABINET 120	120	13.4	3.9	19.3	13.01
IL-KEY CABINET 200	200	16.5	5.1	20.1	17.42

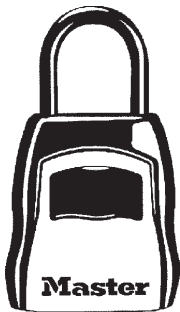

Portable
5400D



Wall Mount
5401D

SELECT ACCESS
Key Storage Security Program
 No Lockouts — No Schedule Conflicts

Master Lock.



Large key storage compartment—holds over 5 door or car keys. 4-dial resettable combination lock—provides simple, set-your-own combination convenience. Solid die cast body—reinforced to withstand hammering and sawing. Zinc lock body and shutter door—weather resistant for years of dependable operation.

©ZIPF LOCK COMPANY