

ZIPF LOCK COMPANY

FILE CABINET LOCKING BARS



SWING-A-WAY

There are no clutter problems with the self-contained Swing-A-Way Locking Bar. The bar remains permanently on the file whether or not the file is in use. Heavy duty cold rolled steel gives the Swing-A-Way Locking Bar strength where it is needed. The bars are cadmium plated to permit their use with any color combination. Red signal tape is attached to the backside of each bar to prevent scratches on painted surfaces and to indicate when the bar is in an open position.

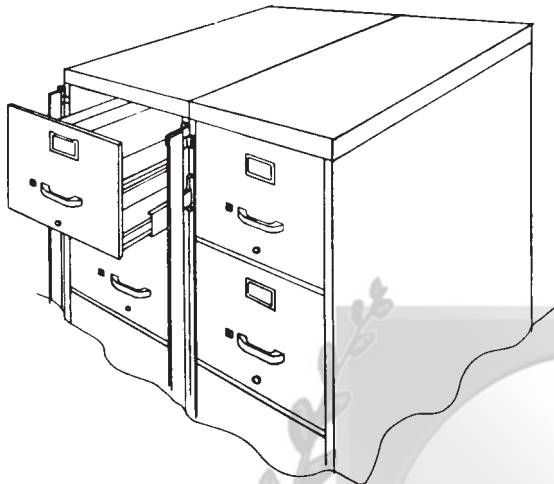

**FULL HEIGHT
DESK PEDESTAL**

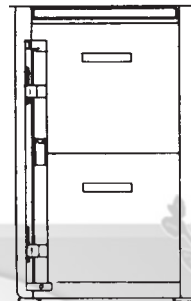

**REGULAR
DESK PEDESTAL**

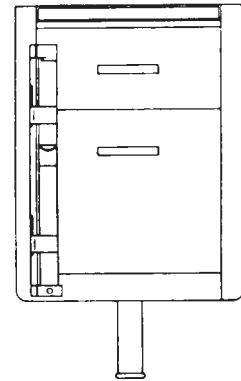

Installed on left side of all filing cabinets. Will not interfere in any way with adjoining files. Available to fit 2, 3, 4 or 5 drawer files.

DRAWING #1

DRAWING #2

Swing-A-Way Locking Bars may be ordered for either full height pedestals or regular pedestals. As with filing cabinets, Locking Bar is installed on left side of the desk pedestal.

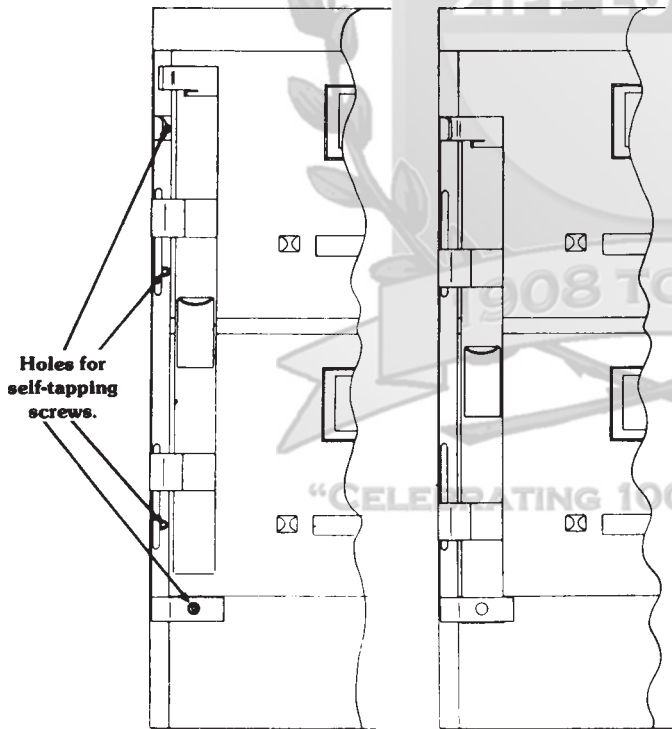

Holes for self-tapping screws.

INSTALLATION

To install—place locking bar as shown in Drawing #1. Drill holes in file or desk pedestal to coincide with holes in the bar. Drill size 7/64" should be used to drill holes for #6 self-tapping screws (enclosed). After screws have been installed and the bar moved to the locked position, the screw heads are inaccessible as shown in Drawing #2.



DRAWING #3

The above drawing shows the locking bar in an open position. Note the positive stop which holds the unlocked bar in position while file or desk is in use.



DRAWING #4

Above drawing shows bar in locked position ready to receive padlock.

<u>Left Hand</u>	<u>Right Hand</u>		<u>Description</u>
<u>Stock No.</u>	<u>Stock No.</u>	<u>Length</u>	
FB-1L	FB-1R	18-3/4"	For desk drawers
FB-2L	FB-2R	23-1/2"	For 2 drawer cabinets
FB-3L	FB-3R	33"	For 3 drawer cabinets
FB-4L	FB-4R	49-1/2"	For 4 drawer cabinets
FB-5L	FB-5R	55"	For 5 drawer cabinets

©ZIPF LOCK COMPANY

364
(PL-30)

”Your warehouse around the corner”

ZIPF LOCK COMPANY

AUXILIARY RIM LOCKS

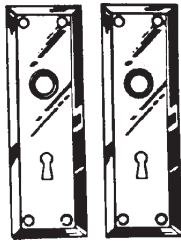

IL-213-04-51
Trim Plates.
Finish: Satin Brass

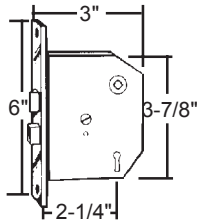

IL-214-04-51
Bit Key Lock.
Finish: Satin Brass

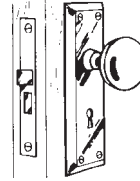

IL-215-04-51
Bit Key Mortise Lock
Finish: Satin Brass

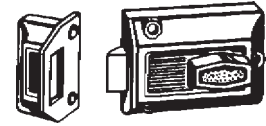

IL-220-53-41
Night Latch.
Finish: Bronze Lacquer

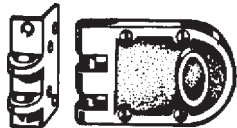

IL-530-53-41
Jimmyproof Deadbolt Lock,
Single Cylinder
Finish: Bronze Lacquer

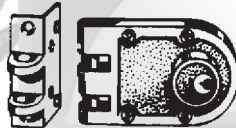

IL-535-53-41
Jimmyproof Deadbolt Lock,
Double Cylinder
Finish: Bronze Lacquer



IL-545-53-41
Surface Deadlock
Finish: Bronze Lacquer

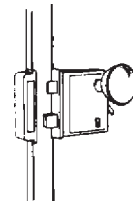

IL-590-04-51
Rim Lockset-Vertical
Finish: Satin Brass

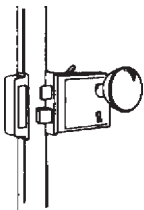

IL-591-04-51
Rim Lockset-Horizontal
Finish: Satin Brass

Finishes

- 04 Satin Brass (paint)
- 53 Bronze Lacquer

S200 SECRET GATE LATCH

Puzzling to the unwelcome!

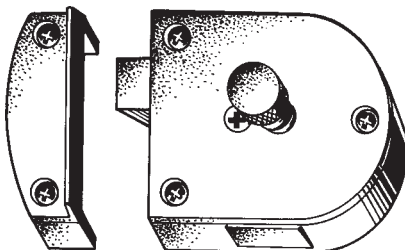

Hidden Button

S200-SPA Aluminum body, sprayed aluminum finish

S200-SPB Aluminum body, sprayed brass finish

- Hidden button in bottom of case retracts latch for the informed.
- Exposed dummy knob frustrates the unwelcome intruder.
- For use on "bank type" office gates where minimum security is required.
- Latch is reversible.
- Supplied with strike plate, mounting screws and dummy knob.
- Approximate case size is 2" x 2-1/2".

©ZIPF LOCK COMPANY

250
(PL-18)

"Your warehouse around the corner"

ZIPF LOCK COMPANY

MISCELLANEOUS

HOOKS — COAT, HAT, ETC.

Coat & Hat Hook

- Especially designed to accommodate large hats.
- Made from cast aluminum.
- Conforms to ANSI/BHMA A156.16 L33121.
- Dimensions:
Base: 2-1/4" H x 1-3/8" W
Projection: 3-5/8"
Overall Height: 5-3/4"



Stock No. (Specify Finish)
IV-575A3
Finishes: 3

Ceiling Hook

- Ideal for use in closets, attached to underside of shelves, or in storage lockers.
- Made from cast aluminum.
- Dimensions:
Base: 1" H x 1-7/8" W
Projection: 2-1/4"



Stock No. (Specify Finish)
IV-580A
Finishes: 3, 92

Wardrobe Hook

- Compact hook is perfect where space is limited, such as behind doors where low profile is needed.
- Made from cast aluminum.
- Dimensions:
Base: 1-1/4" H x 1-1/4" W
Projection: 1-5/8"



Stock No. (Specify Finish)
IV-581A
Finishes: 3, 92

Double Wardrobe Hook

- Compact double hook is perfect where space is limited, such as behind doors where low profile is needed.
- Made from cast brass or cast aluminum.
- Dimensions:
Base, Brass: 1-1/8" H x 1-1/4" W
Base, Aluminum: 1-1/16" H x 1-3/16" W
Projection, Brass: 1"
Projection, Aluminum: 1-3/32"

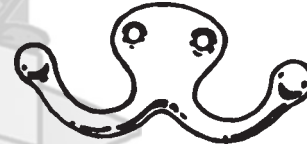

Stock No. (Specify Finish)
IV-582A Cast Aluminum
Finishes: 3, 92
IV-582MB Cast Brass
Finishes: 3, 5, 10B, 15, 15A, 26, 26D

KEY BLOK FOR LEVERS

Stock No	Description
A200 KD	Keyed Different
A200 KA	Keyed Alike

Portable! Light! Strong!

- Fits most lever handle locks.
- Prevents entry of any existing keys.
- Portable! Fits in the palm of your hand.
- Added protection! A new lock in just seconds.
- High strength aluminum alloy.
- Silver Powdercoated Finish

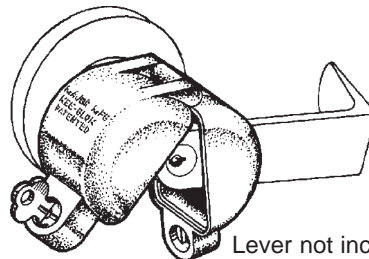

Lever not included

Blocks all existing keys to a lever handle in seconds!

Major
MANUFACTURING, INC.

FITS: Schlage Rhodes, Schlage Oly, Arrow Sierra, Sargent 10 Line Series, Falcon DG, Lockwood Lever, U.S. Lock, Cal Royal Appolo, LSDA Lever, S Parker Hardware, Sargent 6500 Series Lever, AND MANY OTHER MODELS

©ZIPF LOCK COMPANY

442

See page 427 for Cal Royal, Don Jo, Ives finish descriptions.

(PL-42)

"Your warehouse around the corner"

ZIPF LOCK COMPANY

MISCELLANEOUS

HOUSE NUMBERS

Traditional House Numbers

- 4" High.
- Popular traditional styling for easy readability.
- Made from solid wrought brass.
- Conforms to ANSI/BHMA A156.16 L13181.
- Brass brads included.

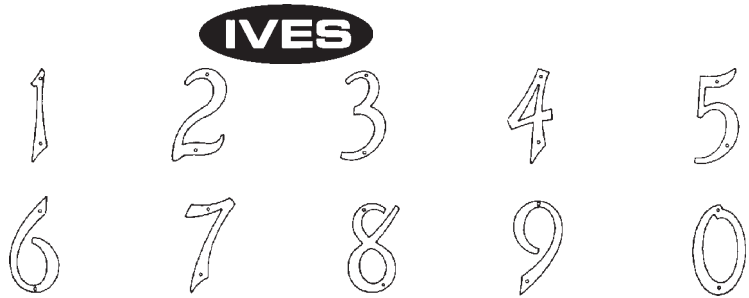

To Order, Specify Stock# & Finish

EX: IV-3004-619

Finishes: 605, 619, 620

Stock#	House Number	Stock#	House Number
IV-3004-	#0	IV-3054-	#5
IV-3014-	#1	IV-3064-	#6
IV-3024-	#2	IV-3074-	#7
IV-3034-	#3	IV-3084-	#8
IV-3044-	#4	IV-3094-	#9

Contemporary House Numbers

- 5" High.
- Bold, thick design is easy to see from a distance.
- Made from cast brass.
- Mounting screws included.



To Order, Specify Stock# & Finish

EX: IV-3005-619

Finishes: 505, 605, 613, 619, 620, 625

Stock#	House Number	Stock#	House Number
IV-3005-	#0	IV-3055-	#5
IV-3015-	#1	IV-3065-	#6
IV-3025-	#2	IV-3075-	#7
IV-3035-	#3	IV-3085-	#8
IV-3045-	#4	IV-3095-	#9

KEY BLOKS



Stock No	Description
A100 KD	Keyed Different
A100 KA	Keyed Alike

- Prevents entry of any existing keys.
- Portable! Fits in the palm of your hand.
- Added protection! A new lock in just seconds.
- High strength aluminum alloy. Silver powdercoat finish.
- A100 fits 90% of all knob locks.

LETTER BOX PLATES



Sleeves for use with Letter Box Plates

- Made of stainless steel.
- For 1-3/4" hollow core doors.

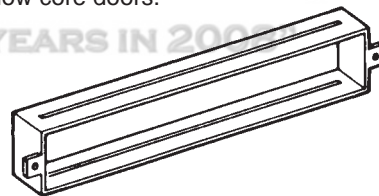

Stock No.	For Letter Box Plates:
IV-601 1-3/4	620, 621, 622 Plates
IV-602 1-3/4	618, 619, 623, 624 Plates

For use with Letter Box Plates on next page.

See page 427 for Cal Royal, Don Jo, Ives finish descriptions.

AUXILIARY RIM LOCKS

Major
MANUFACTURING, INC.



THE VERSATILE SURFACE MOUNTED DEADBOLT

Ideal For: Sliding Patio Doors, Sliding Windows, Swinging Doors, Double Doors, French Doors, Plus!

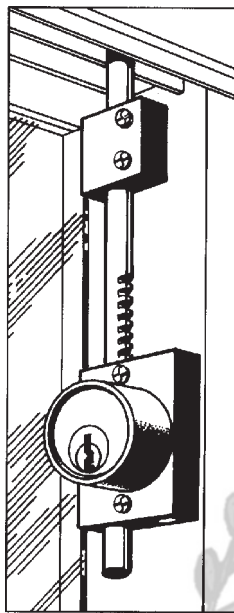

Mortise cylinder not included

Installation at top of center or side of sliding door.

5002-1-9A Aluminum Powdercoat #1 gear

- Can be used on narrow stile doors and frames with a frame width of only 1-5/8".
- Lock housing will accept a standard 1-1/8" mortise cylinder (not included) enabling it to be keyed to other locks in a system.
- Mounts at top or bottom of door or both.
- Equipped with a 3/8" diameter x 9" long locking bolt with a 2-3/8" throw as standard. Other models available by special order.
- Each lock is supplied with a #1 gear (for use with standard mortise cylinders) locking rod, one way screws and instructions.
- Special #2 gear for Medeco mortise cylinder is available by special order.

Yale

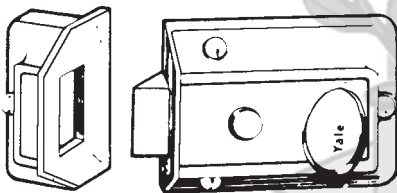

80 Security Latchlock

1/2" throw latchbolt. Key outside, thumbturn inside. Latchbolt held retracted by button. Also can be deadlocked by button. Sprayed brass. 2-3/8" backset. 2-1/2" x 3-5/8".

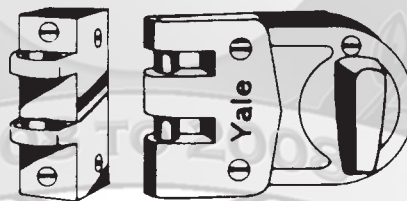

197 Jimmy-Proof Deadlock

Steel interlocking bolts resist prying. Key outside, thumbturn inside. Shutter guard protects against forced entry even if outside cylinder is removed. Sprayed bronze. 2-3/8" backset. 3-5/32" x 4-3/4".

197

Single cylinder-Inswinging

197 1/4

Double cylinder-Inswinging

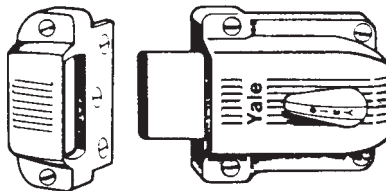

112 Heavy Duty Deadbolt

1-1/8" throw deadbolt. Sprayed brass. 2-3/8" backset. 3-3/8" X 3-1/2".

112

Single cylinder-Inswinging

112F

Single cylinder-Outswinging

112 1/4

Double cylinder-Inswinging

©ZIPF LOCK COMPANY