

# KEYING/SERVICE KITS

## FOR YALE by HPC

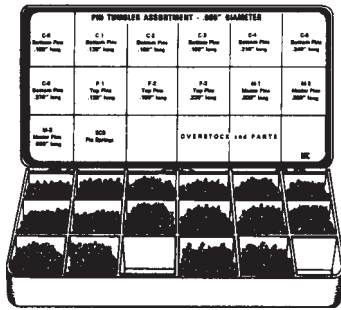

### YPA-095

Pin kit for current Yale cylinders of .095" diameter.  
100 ea. Bottom Pins, #0 thru #6  
100 ea. Top Pins, #1 thru #3  
100 ea. Master Pins, #1 thru #3  
144 Cylinder Springs (LCS)  
Packed in Plastic Box.

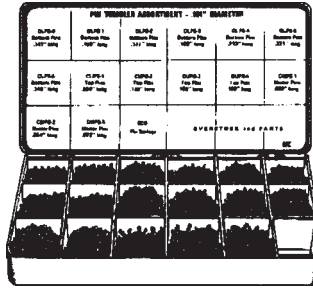

### YPA-101

Pin kit for current Yale cylinders of .101" diameter.  
100 ea. Bottom Pins, #0 thru #6  
100 ea. Top Pins, #1 thru #4  
100 ea. Master Pins, #1 thru #3  
144 Cylinder Springs (LCS)  
Packed in Plastic Box.

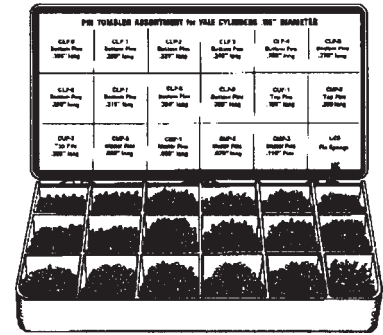

### YPA-115

Pin kit for current Yale cylinders of .115" diameter.  
100 ea. Bottom Pins, #0 thru #9  
100 ea. Top Pins, #1 thru #3  
100 ea. Master Pins, #0 thru #3  
144 Cylinder Springs (LCS)  
Packed in Plastic Box.

## HPC

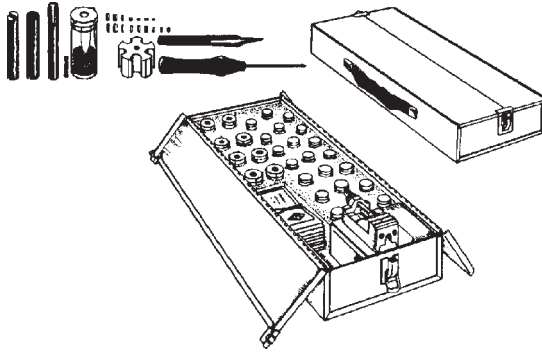

### COKO-5 Carry-Out Keying Kit

This handy kit contains almost everything needed to handle outside keying jobs. Follow through tools, plug holders, pins, cylinder springs, tailpieces and tweezers are all contained in this kit. An excellent machinist's vise swings up on a hinged plate, ready for instant use. The inside of the lid is lined with foam tape to keep all interior parts where they belong. The kit measures 17-1/2" x 7-1/2" x 3-1/4".

## LAB

### PIN TRAY

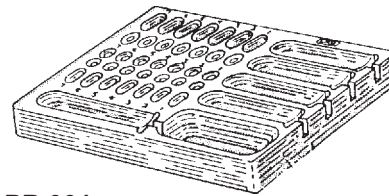

### LB-LPB 001

- Made of Apple Wood
- 5 Plug Availability
- Use with Fingers or Tweezers

## LAB

### VIAL STADIUM

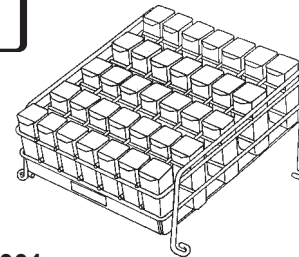

### LB-LSS 001

- Holds 35 LAB pin vials
- Tie-Down feet for easy mounting on wall, bench or van
- Vials not included

# LOCKSMITH TOOLS

## CLIP TOOL



SET OF TWO

### CR-2

The HPC Clip Tool (CR-2) has been designed to remove C type snap rings quickly, easily and safely. The Clip Tool will remove snap rings found on: Schlage F Line Knob Locks, Kwikset Knob Locks and Deadbolts, Arrow Knob Locks, Yale Knob Locks, Lori Rim Cylinders and more.

## MULTI-TOOL



### ES-CJ-34 Multi-Tool

Here's a truly unique tool with hundreds of different uses! The ES-CJ-34 is just what the doctor ordered for pulling small springs, especially on mortise locks or knob tension springs on Schlage L locks or on any lock where there's no room to use your fingers or pliers. What's more, it's great to take tru-arc rings off of cylinders and it's a tremendous aid in taking the caps off key-in-knob cylinders and rim cylinders such as those made by Lori, Arrow, AWI, Dexter, Sargent and Schlage, to mention a few. Other uses include depressing the pin to remove Corbin and Russwin knobs and taking the wedge out of Schlage A80 cylinder Locks.

Those are just some of the uses, but as you work with the Multi-Tool, you'll discover uses we never even thought about! Developed by a professional locksmith, it's the handiest tool to come down the road in years!

## CURVED SHIM

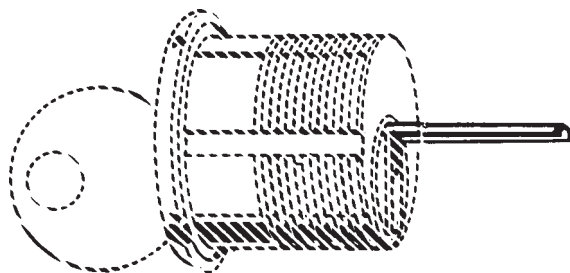

**SCS-25** Package of 25  
**SCS-100** Package of 100

## WAFFLE TRAY

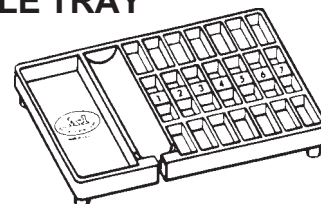

### A1-WT1

Keep springs, pins and plugs neatly separated and in numbered pockets with this popular tool. Manufactured from coated metal, the Waffle Tray is compact and stackable.



## THE GRABBER

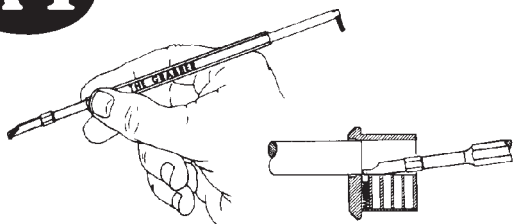

### A1-TG1

If you're tired of dropping pins and springs from conventional tweezers, order A-1's Grabber. Pins and springs snap into this double ended tool. While they are held firmly, they release almost at will. MADE OF SOLID BRASS.

## THE DOWNIE PIN

### A1-DP1

This is a handy tool for manipulation in tight areas. A valuable addition to any pro's toolbox, it's just right for so many jobs. Set includes two pins and a carrying case.

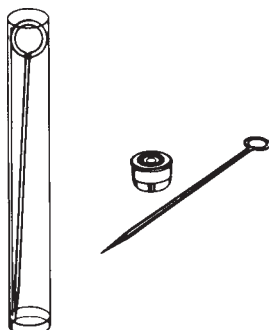

## PIN BLOCK

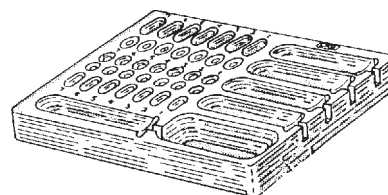

### LB-LPB 001

The Pin Block is made of Maplewood and can hold 5 plugs. Use with your fingers or tweezers. Actual size: 5" x 4-1/2".

## COMPACT PIN TUMBLER TWEEZERS

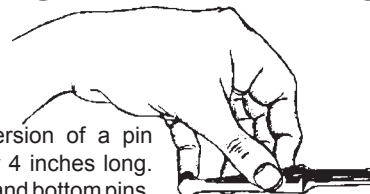

### PTT-5

Another, but shorter version of a pin tumbler tweezers. Only 4 inches long. Milled tips firmly grip top and bottom pins. A compact, pocket-sized keying aid.