

ORIGINAL CYLINDER KEY BLANKS

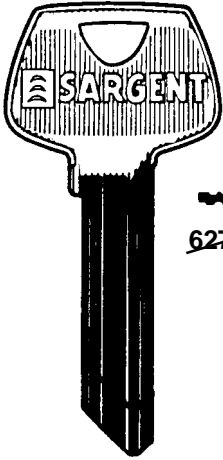

Sargent original key blanks have been discontinued. Limited supply still available. We also stock Ilco and Jet key blanks in select Sargent keyways.

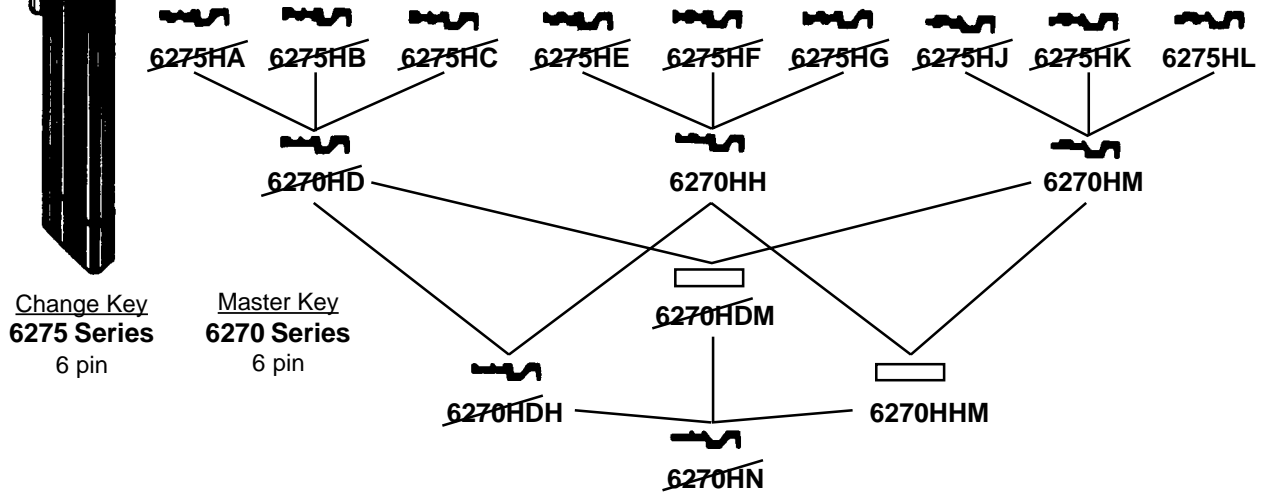

See page 1059 for Ilco blanks for Sargent.

SARGENT

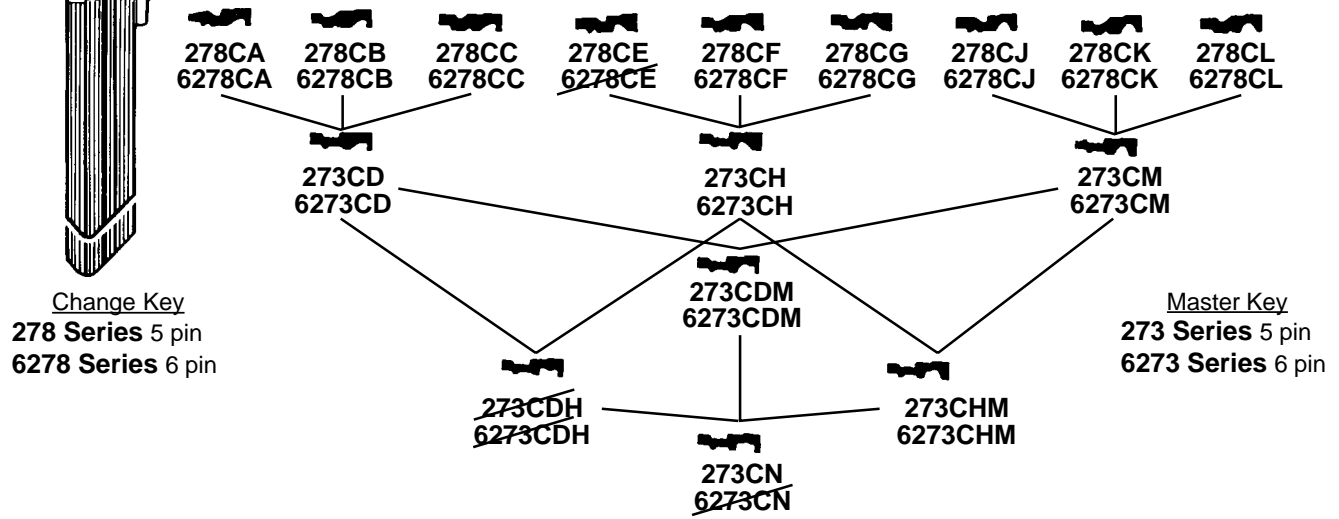
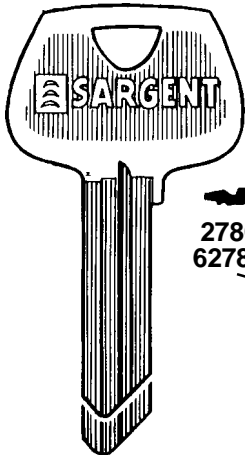

SARGENT

ORIGINAL CYLINDER KEY BLANKS

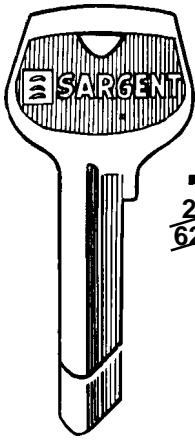

Sarg. IlcoLookAlike
 275LA TA-275LA
 6275LA TA-6275LA
 See page 1072

Sargent original key blanks have been discontinued. Limited supply still available. We also stock Ilco and Jet key blanks in select Sargent keyways.

Change Key
 275 Series 5 pin
 6275 Series 6 pin

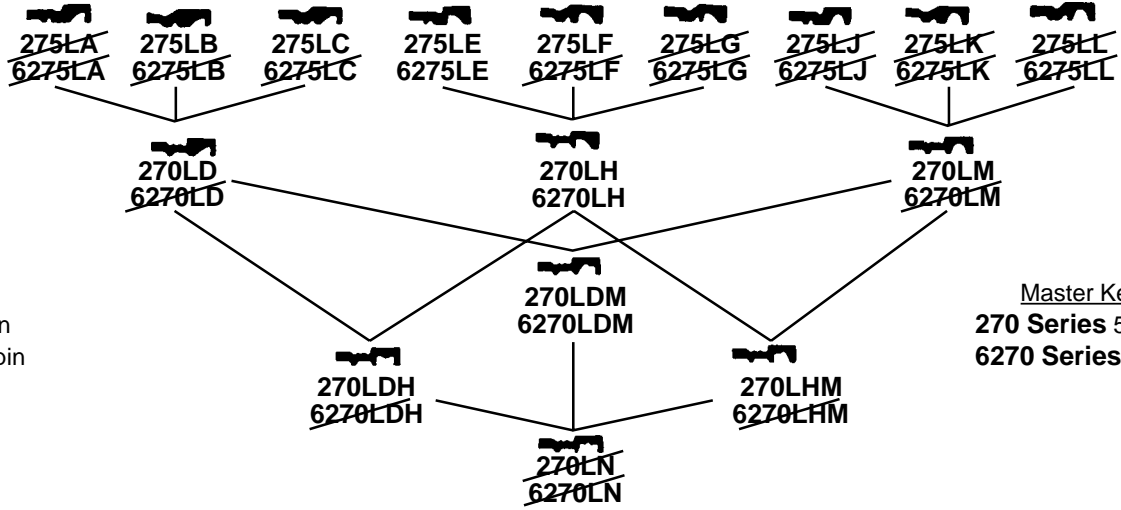

Master Key
 270 Series 5 pin
 6270 Series 6 pin

See page 1060 for Ilco blanks for Sargent.
 See page 1085 of Jet Silver blanks for Sargent

SARGENT

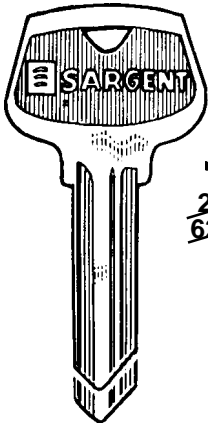

Change Key
 275 Series 5 pin
 6275 Series 6 pin

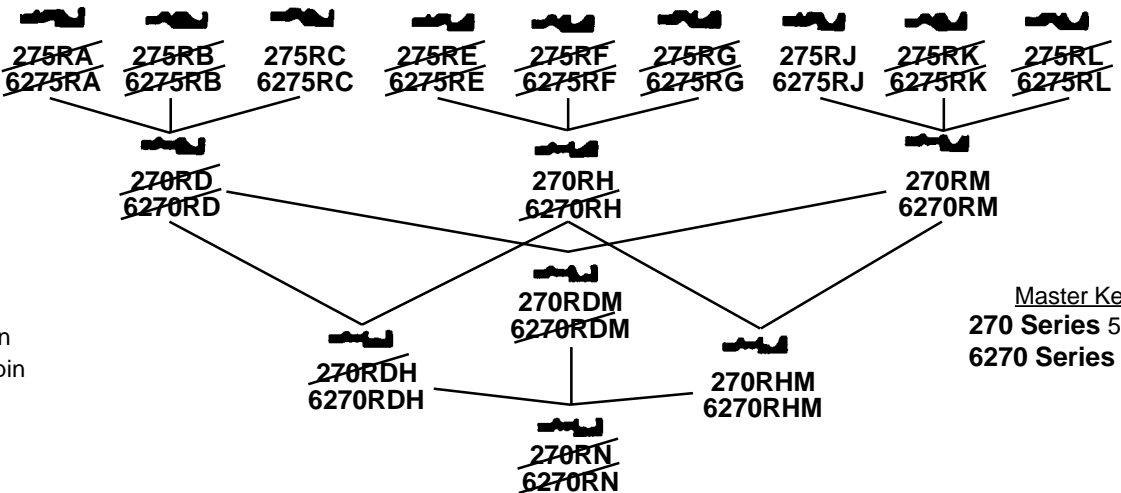

Master Key
 270 Series 5 pin
 6270 Series 6 pin

See page 1061 for Ilco blanks for Sargent.
 See page 1086 of Jet Silver blanks for Sargent

SARGENT

ORIGINAL CYLINDER KEY BLANKS

SARGENT HAS BEEN DISCONTINUED PLEASE CHECK ILCO, JET OR ESP IF OUT OF STOCK.

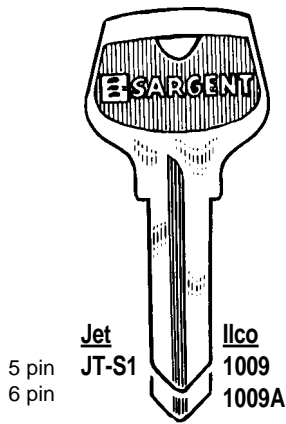

Jet JT-S1
5 pin
6 pin

Ilco 1009
1009A



5 pin
6 pin

265R
6265R

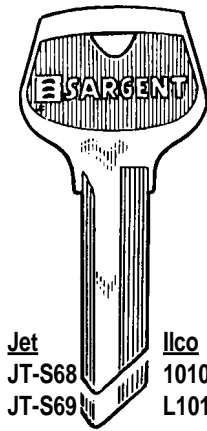

Jet JT-S68
JT-S69

Ilco 1010N
L1010N



~~275S~~
6275S

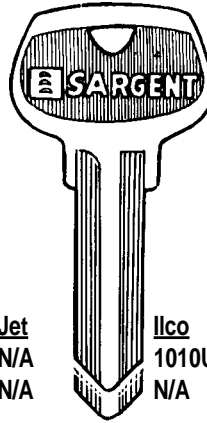

Jet N/A
N/A

Ilco 1010U
N/A



~~265U~~
6265U

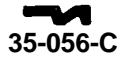
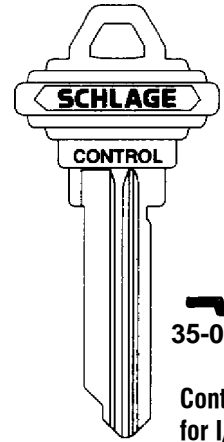

35-056-C

Control Key
for I/C core



35-056-E
SCHLAGE

SARGENT

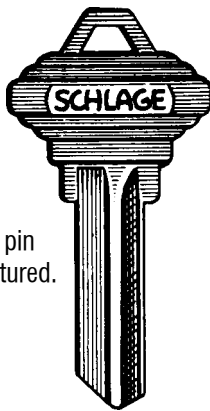

Schlage 5 pin
blanks pictured.



5 pin 35-100C
6 pin 35-101C

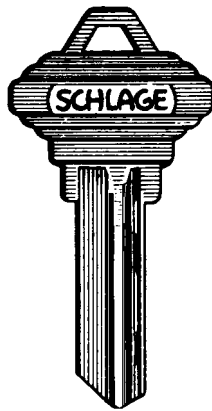

5 pin 35-100CE
6 pin 35-101CE

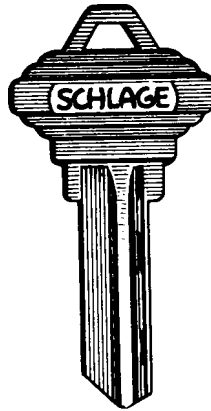

5 pin 35-100E
6 pin 35-101E

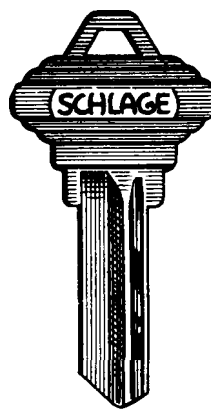

5 pin 35-100EF
6 pin 35-101EF

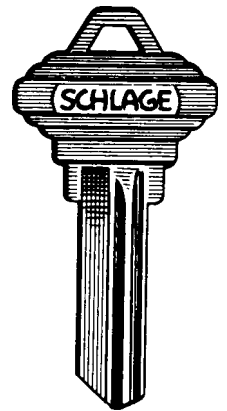

5 pin 35-100F
6 pin 35-101F

SCHLAGE

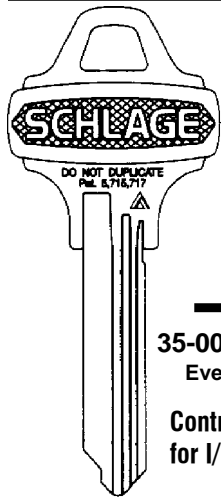

35-003-C123
Everest C

Control Key
for I/C core

35-003-C145
Everest C

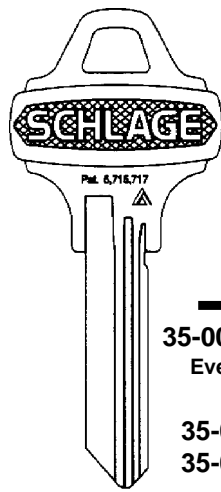

35-009-C123
Everest C

35-009-C123 250PK
35-009-C145 250PK
Everest C

35-009-C145
Everest C

SCHLAGE

We stock many
PRIMUS® key blanks.
Give us a call with
your needs.

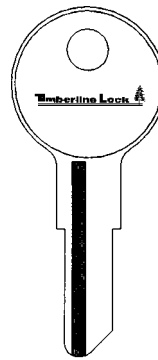

TB-D300KY

TIMBERLINE

NOT
PICTURED
TB-D500KY
Change Tool
(Key)

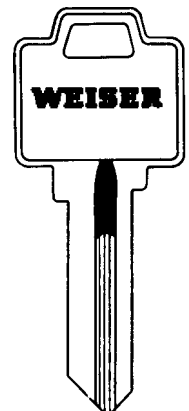

1555 NS

WEISER

ILCO CYLINDER KEY BLANKS



SAGER

SARGENT

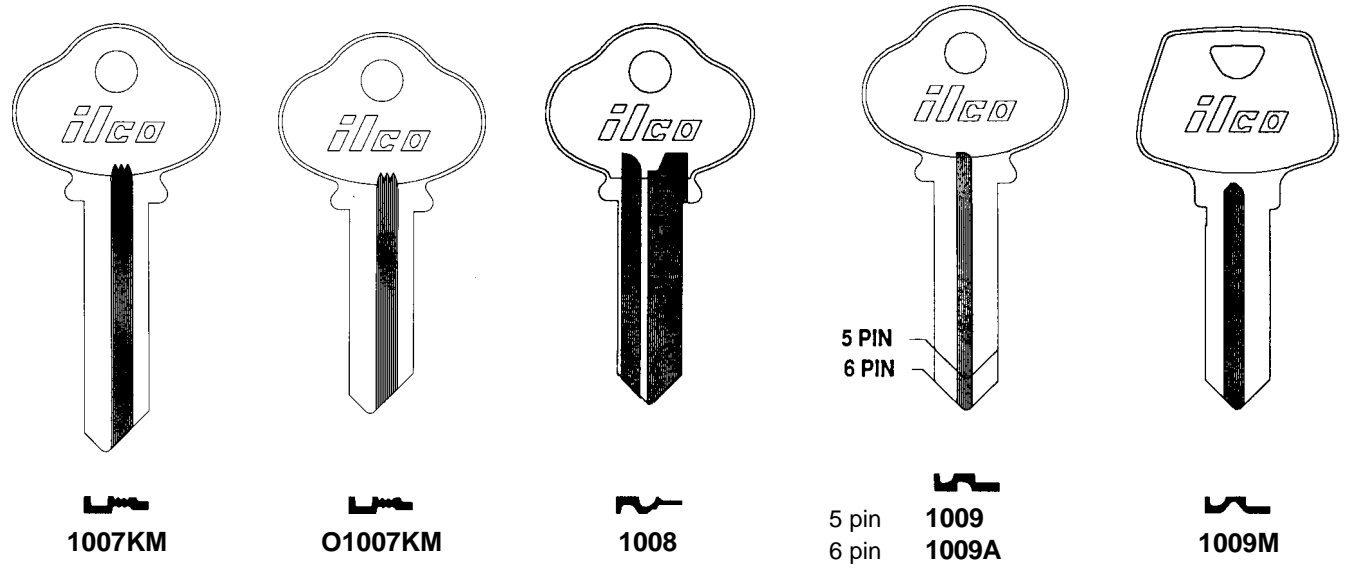

SARGENT

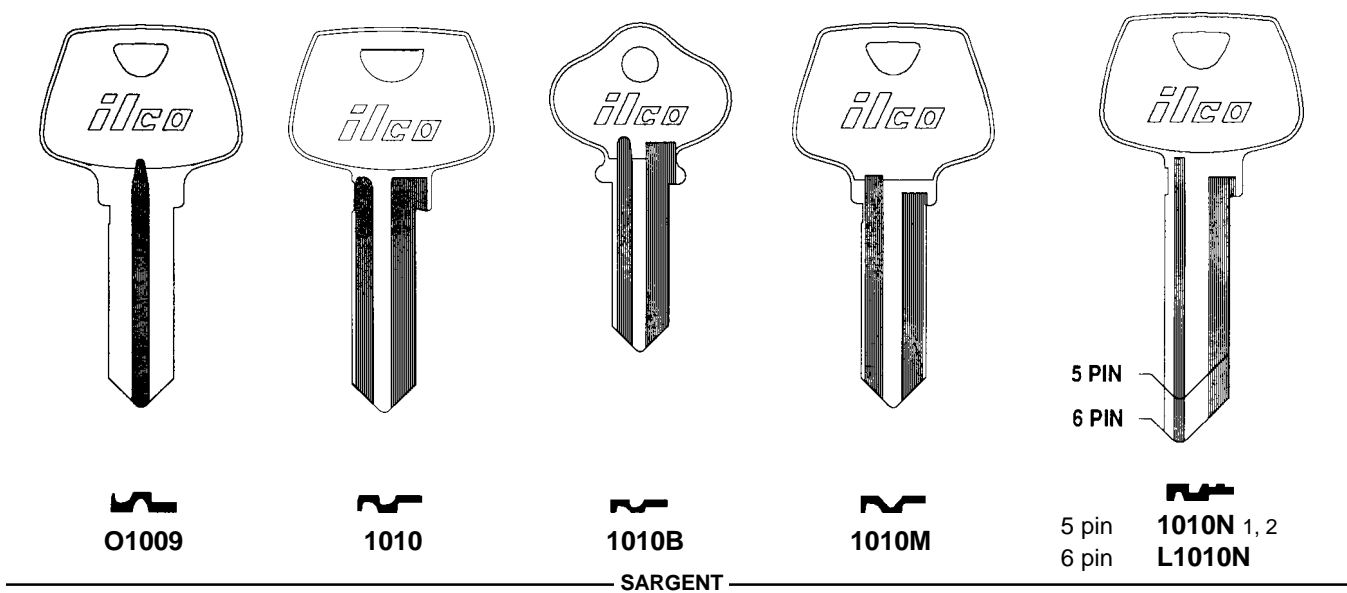

SARGENT

ILCO CYLINDER KEY BLANKS

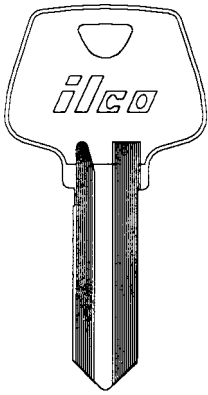

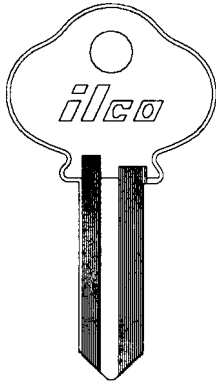

1010U

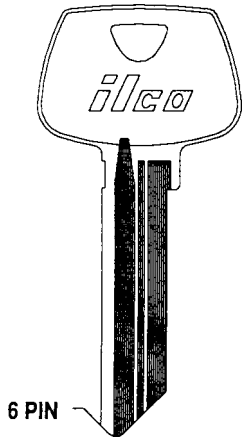
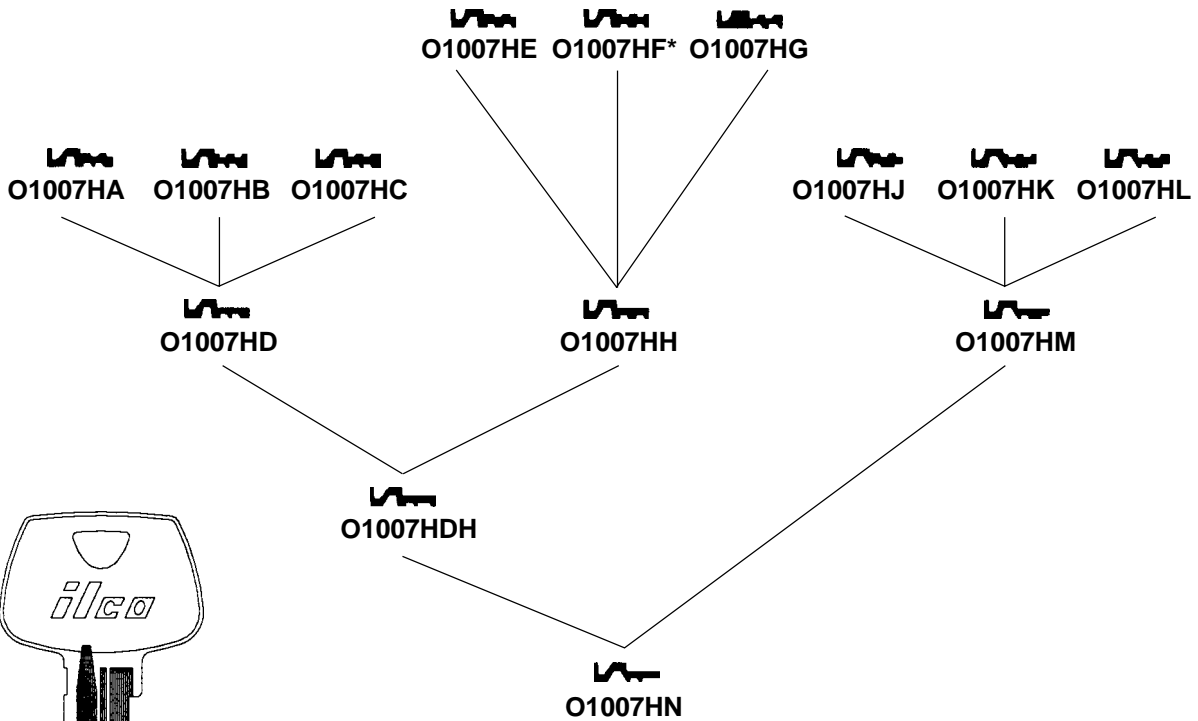

O1010

SARGENT















6 PIN



All blanks on this page are 6 pin.
5 pin versions available by
Special Factory Order only.
*O1007HF special order also.

SARGENT

ILCO CYLINDER KEY BLANKS

5 pin	 1007LA (1)	 1007LB	 1007LC	 1007LE	 1007LF	 1007LG	 1007LJ	 1007LK	 1007LL
6 pin	O1007LA (1)	O1007LB	O1007LC	O1007LE	O1007LF	O1007LG	O1007LJ	O1007LK	O1007LL

5 pin	 1007LD*	 1007LH	 1007LM*
6 pin	O1007LD*	O1007LH*	O1007LM*

5 pin	 1007LDH*	 1007LDM*	 1007LHM*
6 pin	O1007LDH*	O1007LDM*	O1007LHM*



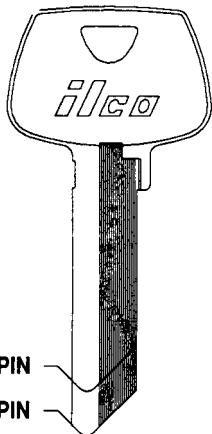















5 pin	 N1007KMB
6 pin	N1007KMA















*Factory Special Order



SARGENT

ILCO CYLINDER KEY BLANKS

5 pin	 1007RA (1)	 1007RB	 1007RC	 1007RE	 1007RF	 1007RG	 1007RJ	 1007RK	 1007RL
6 pin	 O1007RA (1)	 O1007RB	 O1007RC	 O1007RE	 O1007RF	 O1007RG	 O1007RJ	 O1007RK	 O1007RL

5 pin	 1007RD*	 1007RH*	 1007RM*
6 pin	 O1007RD*	 O1007RH*	 O1007RM*

5 pin	 1007RDH*	 1007RDM*	 1007RHM*
6 pin	 O1007RDH*	 O1007RDM*	 O1007RHM*

5 pin	 N1007RMB
6 pin	 N1007RMA

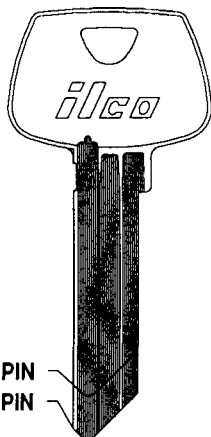



*Factory Special Order

SARGENT

ILCO CYLINDER KEY BLANKS

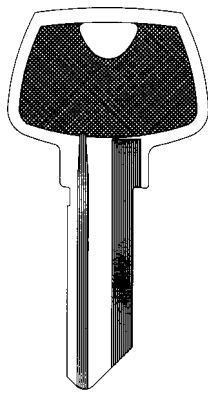
LOOK-A-LIKE KEY BLANKS



 TA-275S NS

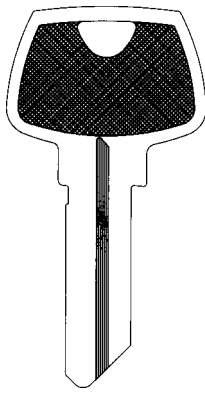

 TA-275LA NS
SARGENT

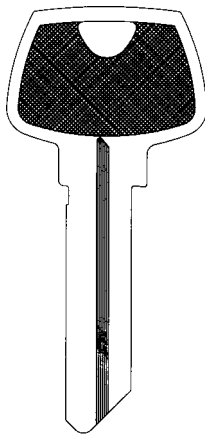

 TA-6275LA NS

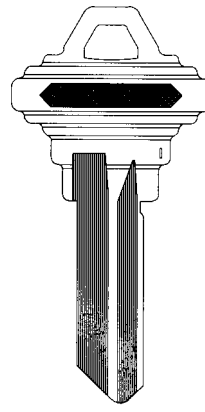

 TA-100C NP
TA-100C NS

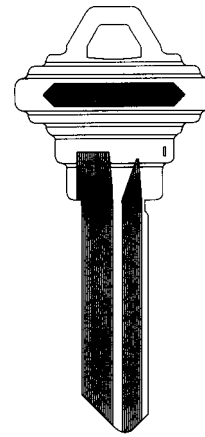

 TA-101C NP
TA-101C NS
SCHLAGE

 TA-101E NP
TA-101E NS

 TA-101CE NS

 TA-101EF NS

 TA-101F NP
TA-101F NS

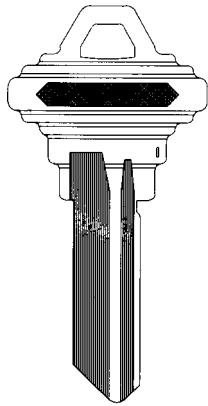

 TA-100E NP
TA-100E NS

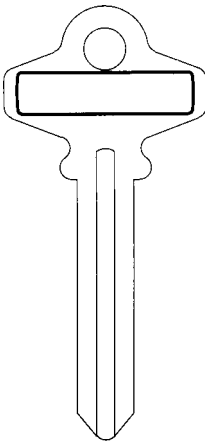

 TA-180A NP
SCHLAGE

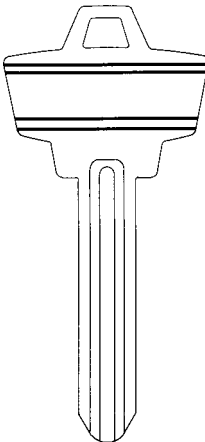

 TA-200W NP

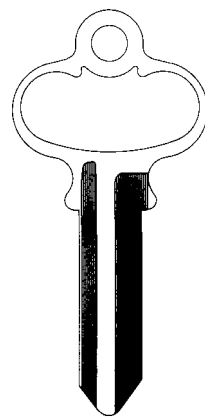

 TA-K9
SEGAL

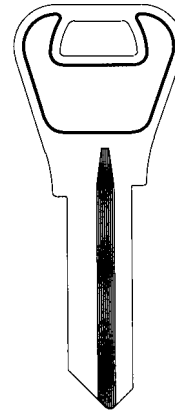

 TA-1555 NP
TA-1555 NS

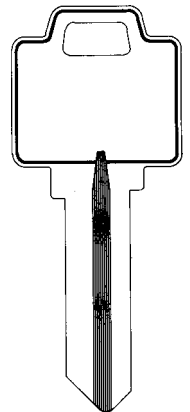

 TA-P1555 NP
TA-P1555 NS
WEISER

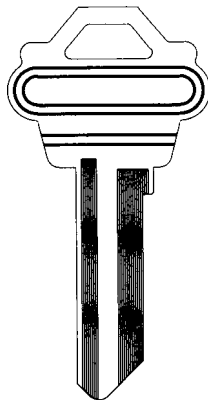

 TA-12344 BR
TA-12344 NS
WESLOCK

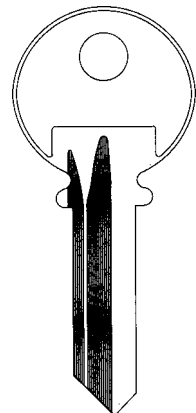

 TA-8

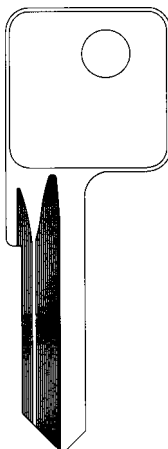

 TA-E8

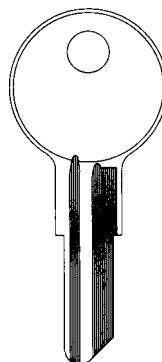



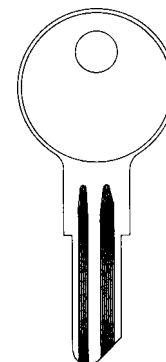





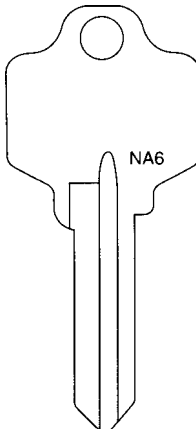

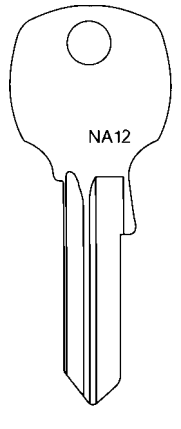

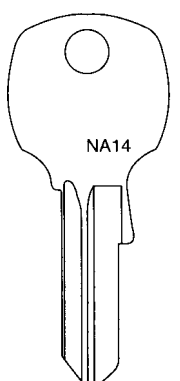

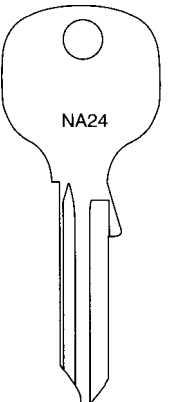

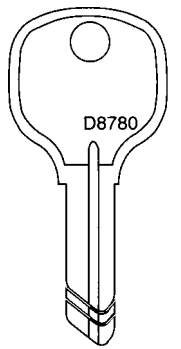

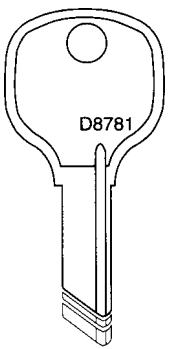

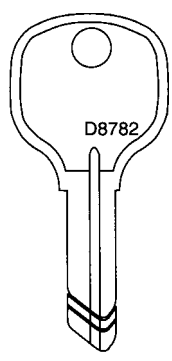

 TA-9114
YALE

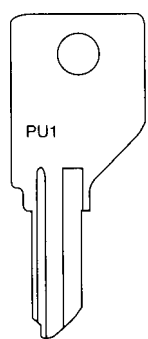

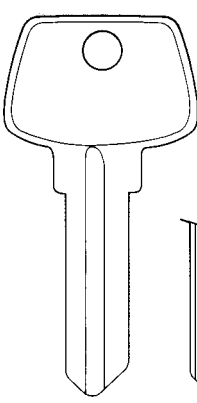
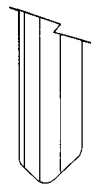

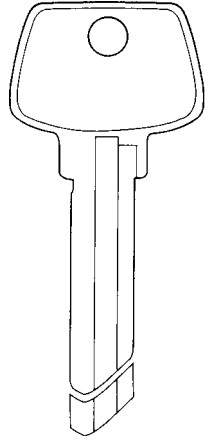
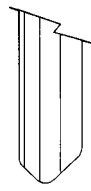

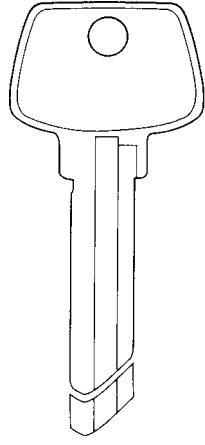

 TA-9278

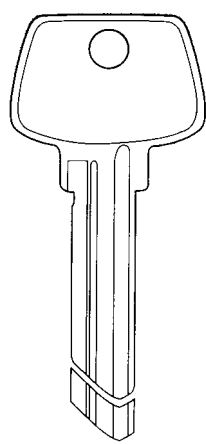
JET CYLINDER KEY BLANKS

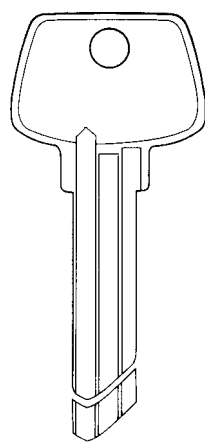
 NA6  JT-NA6	 NA12  JT-NA12 JT-NA12-250 (250 Blanks in Bulk Pack)	 NA14  JT-NA14	 NA24  JT-NA24	 D8780  4 pin JT-D8780 5 pin JT-D8783 6 pin JT-D8787	 D8781  4 pin JT-D8781 5 pin JT-D8784 6 pin JT-D8788
NATL ROCKFORD					

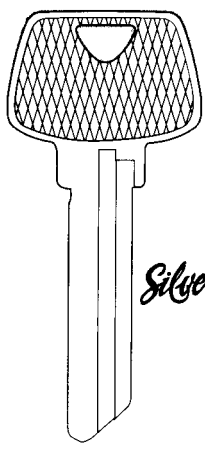
 D8782  4 pin JT-D8782 5 pin JT-D8785 6 pin JT-D8789	 PU1  JT-PU1 PUNDRA	FOR RUSSWIN SEE CORBIN/RUSSWIN RUSSWIN	   JT-S1 "R"	   JT-S4 "U"	  5 pin JT-S16 6 pin JT-S6
NATL ROCKFORD		RUSSWIN		SARGENT	

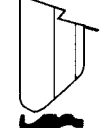
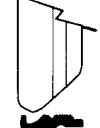
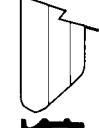
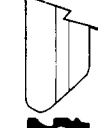
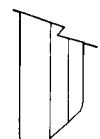
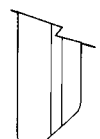
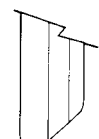
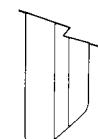
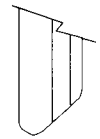
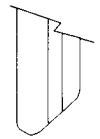
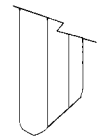
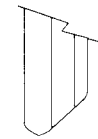
  5 pin JT-S22-1/2LA 6 pin JT-S22LA	  5 pin JT-S32	 Silver  JS-6275LAN S	 JS-6275LBNS	 JS-6275LCNS	 JS-6270LDNS	 JS-6275LENS
SARGENT			 JS-6275LFNS	 JS-6275LGNS	 JS-6270LHNS	 JS-6275LJNS
SARGENT			 JS-6275LKNS	 JS-6275LLNS	 JS-6270LMNS	 JS-6270LNNS

JET CYLINDER KEY BLANKS

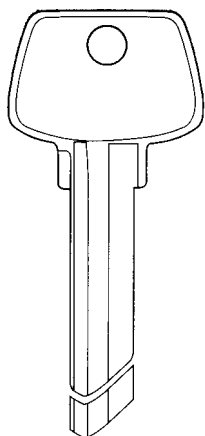

5 pin **JT-S68**
6 pin **JT-S69**

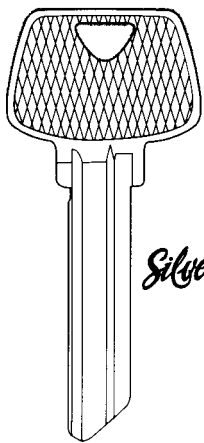

JS-6275RANS

Silver

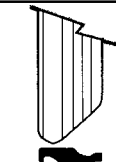

JS-6275RBNS

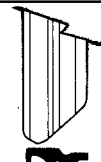

JS-6275RCNS

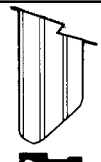

JS-6270RDNS

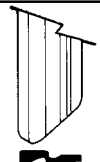

JS-6275RENS

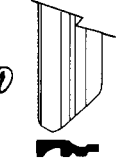

JS-6275RFNS

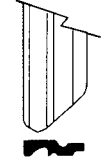

JS-6275RGNS

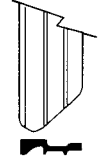

JS-6270RHNS

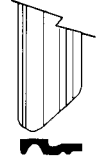

JS-6275RJNS

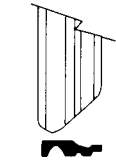

JS-6275RKNS

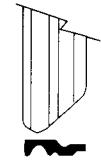

JS-6275RLNS

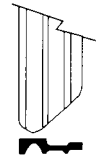

JS-6270RMNS

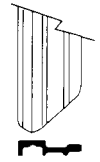

JS-6270RNNS

SARGENT

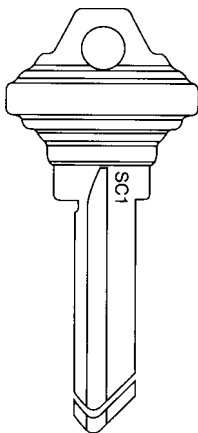

5 pin **JT-SC1 1**
6 pin **JT-SC4 1**

JT-SC1-250
JT-SC1NP-250
JT-SC4-250
(250 Blanks in Bulk Pack)

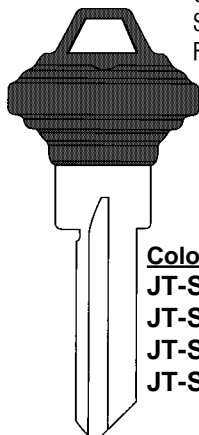

JT-SC1 PHC ASST
(2ea Blue, 1ea balance)

SCHLAGE

Also stock SC1 with Groovy Designs. See Inside Front Cover.



Color Plastic Head

- JT-SC1 PHC B** Blue
- JT-SC1 PHC G** Green
- JT-SC1 PHC R** Red
- JT-SC1 PHC Y** Yellow

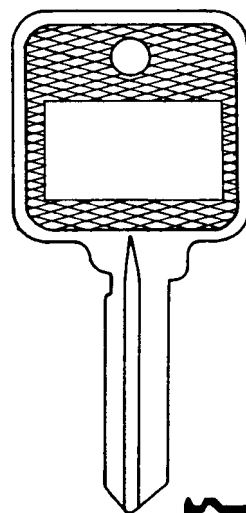

JT-SC1RH

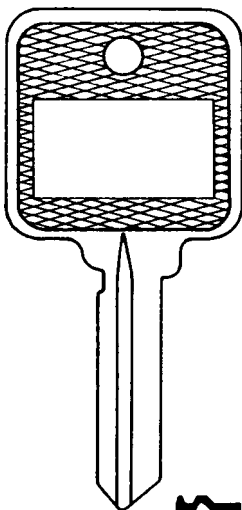

JT-SC4RH

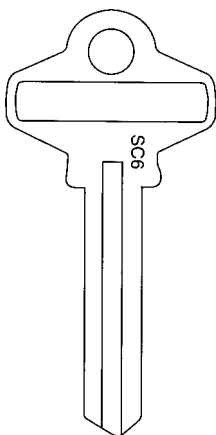

JT-SC6

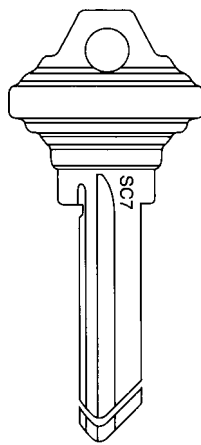

5 pin **JT-SC7**
6 pin **JT-SC10**

SCHLAGE

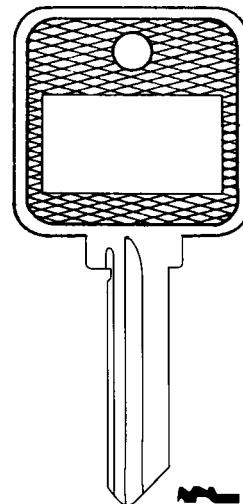

JT-SC10RH